

# SEIP

RESIDENTIAL DOORS

SERIE SR SRV SLD SLS SP  
SERIES



# INDICE

# INDEX

**P.6** / PORTE SEZIONALI RESIDENZIALI PER GARAGE  
RESIDENTIAL SECTIONAL GARAGE DOORS

**P.8** / LE UNICITÀ E LE INNOVAZIONI  
DELLE NOSTRE PORTE SEZIONALI PER GARAGE  
UNIQUENESS AND INNOVATIONS OF OUR  
SECTIONAL GARAGE DOORS

**P.16** / CATEGORIE ESTETICHE  
PANNELLI SERIE SR-SRV-SLD-SLS  
PANELS PATTERNS CATEGORIES  
SR-SRV-SLD-SLS SERIES

**P.18** / ESTETICA BIDOGA  
DOUBLESLAT PATTERN  
MODELLO / MODEL TOCANTINS  
MODELLO / MODEL GOIAS  
MODELLO / MODEL SAO PAULO

**P.22** / ESTETICA PIANA  
PLANAR PATTERN  
MODELLO / MODEL RONDONIA  
MODELLO / MODEL BAHIA  
MODELLO / MODEL AMAZONAS

**P.26** / ESTETICA MULTIDOGA  
MULTISLAT PATTERN  
MODELLO / MODEL SERGIPE  
MODELLO / MODEL PARANÀ  
MODELLO / MODEL AMAPÀ

**P.30** / ESTETICA VENEZIANA  
VENETIAN PATTERN  
MODELLO / MODEL PARÀ

**P.32** / ESTETICA CASSETTATA  
CAISSONED PATTERN  
MODELLO / MODEL ALAGOAS

**P.34** / MADEIRA LA PORTA DA GARAGE  
ELEGANTE E RAFFINATA  
MADEIRA THE GARAGE DOOR  
ELEGANT AND REFINED

**P.36** / PORTE SEZIONALI SCORRIMENTO LATERALE  
SECTIONAL DOORS WITH LATERAL SLIDING

**P.38** / PORTA PEDONALE PASSO-UOMO LATERALE  
LATERAL PEDESTRIAN DOOR

**P.41** / PORTA PEDONALE BREVETTATA  
PATENTED WICKET DOOR

**P.42** / SEZIONALE PANORAMA SERIE SP  
PANORAMA SECTIONAL SP SERIES

**P.44** / RIEPILOGO ESTETICHE E COLORI  
PATTERNS AND COLOURS SUMMARY

**P.46** / ACCESSORI - MOTORIZZAZIONE  
ACCESSORIES - MOTORISATION

**P.51** / INGOMBRI E TIPI DI INSTALLAZIONE  
DIMENSIONS AND METHODS OF INSTALLATION

**P.62** / PROCESSI INDUSTRIALI  
ALL'AVANGUARDIA  
ADVANCED INDUSTRIAL  
PROCESSES

## UN BRAND DEL GRUPPO SILVELOX A BRAND OF THE SILVELOX GROUP

Seip residential oggi è il marchio che identifica le porte per garage sezionali per il mercato residenziale all'interno di **Silvelox Group SpA**. Un progetto industriale nel settore delle chiusure per garage partito nel 2007. La forza della sua strategia è di detenere la proprietà formale e intellettuale del know-how in ambito tecnico, di progettazione e di produzione di componenti, accessori e profili; questa differenziazione rispetto ai normali assemblatori, ha garantito all'azienda una crescita costante ed una posizione di rilievo sempre maggiore all'interno del competitivo mercato dei produttori di chiusure per garage. L'alta automatizzazione dei processi e l'industrializzazione del ciclo produttivo, favoriscono elasticità e tempi di consegna ridotti, garantendo in ogni caso l'alto livello qualitativo dei prodotti e del servizio.

Un gamma completa di estetiche e funzionalità per coprire tutte le soluzioni di chiusure sezionali. Un forte orientamento industriale con la copertura di numerosi brevetti che dal 2019 ha reso possibile l'apertura ai mercati internazionali.

Seip residential today is the brand that identifies sectional garage doors for the residential market within **Silvelox Group S.p.A**.

An industrial project in the sector of garage doors that started in 2007. The strength of its strategy is to hold the formal and intellectual property of the know-how in the technical, design and production fields of components, accessories and profiles; this differentiation from normal assemblers has ensured the company constant growth and an increasingly important position within the competitive market of garage door manufacturers. The high automation of processes and the industrialization of the production cycle favor flexibility and reduced delivery times, guaranteeing in any case the high quality level of products and service.

A complete range of aesthetics and functionality to cover all sectional closure solutions. A strong industrial orientation with the coverage of numerous patents that since 2019 has made it possible to open up to international markets.





5

Serie SR  
Estetica Piana  
Modello Rondonia  
Corten RO CO

Serie SR  
Pattern Planar  
Model Rondonia  
Corten RO CO

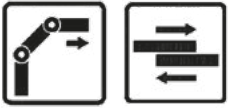

# PORTE SEZIONALI RESIDENZIALI PER GARAGE SR-SRV-SLD-SLS

# RESIDENTIAL SECTIONAL GARAGE DOORS SR-SRV-SLD-SLS

La porta sezionale è composta da pannelli orizzontali, collegati fra loro mediante cerniere e che scorrono verticalmente disponendosi a fine apertura parallelamente al soffitto. Questo particolare meccanismo consente l'utilizzo di tutta la superficie interna del garage. Le dimensioni massime sono **L = 7,5 m - H = 3,25 m per SR**; **L = 6 m - H = 3,25 m per SLS** e **L = 12 m H = 3,25 per SLD**.

Le porte Seip Residential Door oltre a garantire la sicurezza delle persone, rispettano anche l'ambiente, essendo composte da materiali non inquinanti (esenti da CFC) che permettono l'isolamento termico e favoriscono allo stesso tempo il risparmio energetico.

Seip Residential Door propone due sistemi di porte sezionali a scorrimento verticale: uno con albero molle a rotazione serie SR e il secondo con molle verticali a trazione serie SRV. Silvelox propone anche porte residenziali a scorrimento laterale serie SLD e SLS.

A sectional door is made of horizontal panels, connected with hinges that slide vertically until they are parallel to the ceiling, once the door is completely open.

This particular system allows the use of the entire internal surface of the garage. Maximum measures are **W = 7,5 m - H = 3,25 m per SR**; **W = 6 m - H = 3,25 m per SLS** e **W = 12 m H = 3,25 per SLD**.

Seip Residential Door are safety for people and environment friendly, since they are made with non-polluting materials which favour both thermal insulation and energy savings at the same time.

Seip Residential Door offers two systems of sectional vertically sliding doors: the first one works with springs on a torsional shaft (SR series) and the second one works with vertical traction springs (SRV series). Silvelox also proposes sectional lateral sliding doors (SLD and SLS series).



**SEIP**  
RESIDENTIAL DOORS

Serie SR  
Estetica Piana  
Modello Rondonia  
Ral 9010 RO BI

Serie SR  
Pattern Planar  
Model Rondonia  
Ral 9010 RO BI





# LE UNICITÀ E LE INNOVAZIONI DELLE NOSTRE PORTE SEZIONALI PER GARAGE

## UNIQUENESS AND INNOVATIONS OF OUR SECTIONAL GARAGE DOORS

MOTORIDUTTORE  
MODELLO "HALO"  
CON SISTEMA INTEGRATO  
DI ILLUMINAZIONE  
INTERNA A LED



"HALO" DOOR  
OPERATOR COMPLETE WITH INDOOR  
LED LIGHTING

ISOLAMENTO TERMICO  
E RISPARMIO ENERGETICO  
CON MATERIALI NON INQUINANTI  
ESENTI DA CFC

THERMAL INSULATION  
AND ENERGY SAVING  
WITH NON-POLLUTING MATERIALS  
CFC FREE





## DISPOSITIVO ELETTRONICO MT600

MT600 è il dispositivo elettronico che consente l'azionamento di un cancello o una porta da garage, utilizzando uno smartphone.

## MT600 ELECTRONIC DEVICE

MT600 is the electronic device that allows the operation of a gate or a garage door, using a smartphone.

## APP SILVELOX

App dedicata al cliente finale per l'apertura della porta tramite smartphone.

Module for automation control from smartphone.





**FACILITÀ DI MONTAGGIO  
EASY ASSEMBLY**

**THE  
FASTEST  
INSTALLATION  
EVER**

**SEIP**  
RESIDENTIAL DOORS

Serie SR  
Estetica Piana  
Modello Rondonia  
Ral 7016 RO GP

Serie SR  
Pattern Piana  
Model Rondonia  
Ral 7016 RO GP



## FOTOCELLULA DI SICUREZZA TSD BREVETTATA PATENTED TSD SAFETY PHOTOCELL

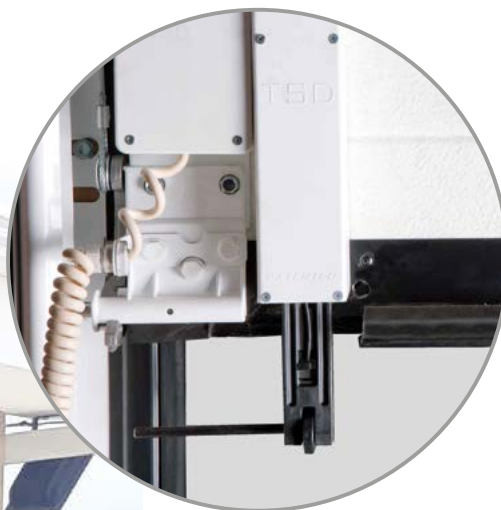

L'innovativo sistema di sicurezza, atto ad evitare eventuali urti e/o schiacciamenti da parte di cose o persone durante la movimentazione automatica delle porte sezionali SR.

The innovative security system, designed to avoid any knock and / or crushing by things or people during the automatic movement of sectional SR doors.

## DISPOSITIVO ANTICADUTA SAFETY DEVICE



Dispositivo anticaduta in caso di rottura delle funi "a scomparsa" brevettato, con meccanismo incorporato nel pannello.

Patented safety system built inside the panels in case of cable breakage.



## MOTORIZZAZIONE MODELLO "HALO" "HALO" MOTORIZATION



Motorizzazione 1000N con guida a cinghia verniciata bianca con illuminazione a led di nostra esclusiva. Disponibile anche con guida a cinghia in acciaio zincato.

1000N motorization with belt guide painted in white complete with our EXCLUSIVE LED lighting. Also available with galvanized steel belt guide.

**SEIP**

RESIDENTIAL DOORS



## SEZIONALE SR CARTER COPRI-MOLLE SPRING COVER

Esclusivo carter copri-molle brevettato che garantisce ottimi risultati estetici.

Patented spring cover that ensures excellent aesthetic and functional results.



Copricarter fissato sul manto BREVETTATO.  
Disponibile solo nello scorrimento WA.  
Optional disponibile SU RICHIESTA.

PATENTED cover fixed on the surface.  
Accessory available only on request

## RULLO CON PROTEZIONE ANTI SCHIACCIAMENTO ROLLER WITH ANTI-CRUSHING SYSTEM

Protezione innovativa che impedisce il potenziale schiacciamento delle dita.  
New safety device that avoids any possible finger injury.



## GUIDE DI SCORRIMENTO SLIDING GUIDES

Guide di scorrimento verniciate bianche a polveri.  
White powder-painted sliding guides.



## CERNIERA LATERALE CON POSIZIONAMENTO RAPIDO SIDE HINGE WITH RAPID POSITIONING

Nuova cerniera laterale brevettata con posizionamento rapido della ruota di scorrimento.

New patented side hinge with rapid positioning of the sliding wheel.



## SISTEMA DI SCORRIMENTO RIBASSATO LOWERED SLIDING SYSTEM

Sistema di scorrimento brevettato che garantisce apertura e chiusura con rotazione in 150 mm e ingombro in architrave di 150 mm con porte motorizzate totalmente aperte.

Patented sliding system which ensures opening and closing within 150 mm rotation and 150 mm lintel, with motorized doors completely open.



## STAFFE FISSAGGIO A SOFFITTO CEILING MOUNTING BRACKETS

l'operazione di montaggio e garantiscono qualità e durata sotto sforzo.  
Ceiling mounting brackets, makes easier the mounting operation and guardantees quality and performance during the lift.



## INSERTO ANGOLARE PER DIMA ANGULAR INSERT FOR C-PROFILE

Inserto angolare per il fissaggio a incastro della dima posteriore con le guide orizzontali.

Facile da assemblare garantisce una forte presa.  
Angular insert for C-profile. Easy to assemble.  
It ensures a firm hold.





## PORTINA PEDONALE BREVETTATA PATENTED PEDESTRIAN DOOR

La porta pedonale è inserita al centro del manto oppure decentrata su richiesta l'altezza della soglia è ridotta al minimo tecnicamente possibile 33 mm. La porta pedonale è disponibile di serie con 1 punto di chiusura ma è possibile arrivare fino a 3 / 5 punti di chiusura che garantiscono il massimo della sicurezza contro furti e intrusioni. A porta aperta la luce netta di passaggio è di 900 mm grazie alla dotazione di cerniere a scomparsa.

- Telaio complanare al pannello.
- Telaio RAL oppure effetto legno simile al manto esterno.
- Micro di sicurezza.
- Non è disponibile nella serie SL.

The pedestrian door is inserted in the center of the curtain or decentralized upon request, the height of the threshold is maximally reduced to 33 mm. The standard pedestrian door is provided with 1 lock, but it is possible to reach up to 3/5 locking points which guarantee maximum security against thefts and intrusions. With the door open, the net passage is 900 mm thanks to the use of concealed hinges.

- Frame coplanar with the panel.
- RAL wood effect to match the external covering.
- Safety micro.
- Not available in the SL series.



Porta pedonale inserita, con soglia ribassata.  
Pedestrian door inserted, with lowered threshold.



Un'apertura comoda e sicura grazie alle protezioni esterne anti schiacciamento dita in fase di movimento e protezioni anti pizzicamento dita interne adesive in materiale termoplastico  
Easy and safe opening thanks to the internal and external anti-pinch protection system made of thermoplastic material.

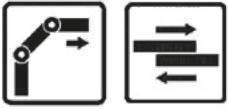

**CATEGORIE  
ESTETICHE  
PANNELLI  
PER SERIE  
SR-SRV-SLD-SLS**

**PANELS PATTERNS  
CATEGORIES  
FOR SERIES  
SR-SRV-SLD-SLS**

 **ESTETICA BIDOGA  
DOUBLESLAT PATTERN**

 **ESTETICA PIANA  
PLANAR PATTERN**

 **ESTETICA MULTIDOGA  
MULTISLAT PATTERN**

 **ESTETICA VENEZIANA  
VENETIAN PATTERN**

 **ESTETICA CASSETTATA  
CAISSONED PATTERN**

**SEIP**  
RESIDENTIAL DOORS





Serie SR  
Estetica Piana  
Modello Rondonia  
Ral 7016 RO GP

Serie SR  
Pattern Piana  
Model Rondonia  
Ral 7016 RO GP



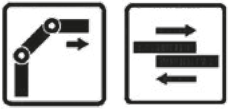

**SERIE SR-SRV-SLD-SLS**  
**SR-SRV-SLD-SLS SERIES**

# ESTETICA BIDOGA DOUBLESLAT PATTERN

Serie SR  
Estetica Bidoga  
Modello Tocantis  
Quercia scuro TO

Serie SR  
Doubleslat Bidoga  
Model Tocantis  
Dark Oak TO



Moderna combinazione di linee per un effetto estetico rigoroso ed essenziale. Finiture lisce e goffrate legno a seconda del modello.  
Modern combination of lines to create a rigorous and essential effect. Smooth finishes and embossed wood depending on the model.

Pannello coibentato in acciaio zincato spessore 0,5 con verniciatura idonea per una collocazione esterna e atta a garantire la massima durata nel tempo. Pannello brevettato con doga centrale di uguale dimensione alla giuntura dei pannelli per garantire un effetto estetico omogeneo.

Insulated panel made of galvanised steel, 0,5 mm thickness with a special painting suitable for external use and perfect to ensure the best duration in time. A patented panel with a central slat of the same dimension of the junction, to ensure a uniform aesthetic effect.

VISTA ESTERNA  
EXTERNAL VIEW

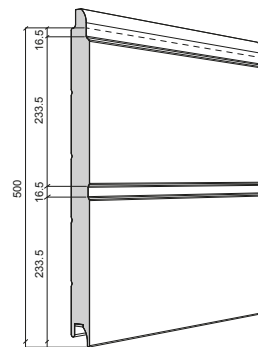

VISTA INTERNA  
INTERNAL VIEW

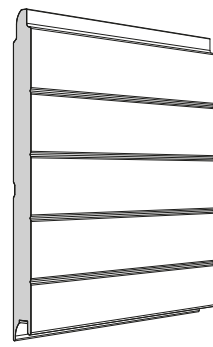

Pannello  
H 500

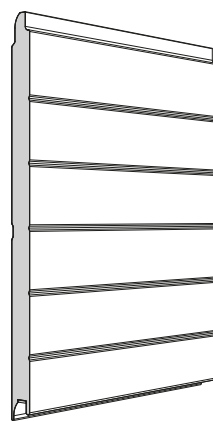
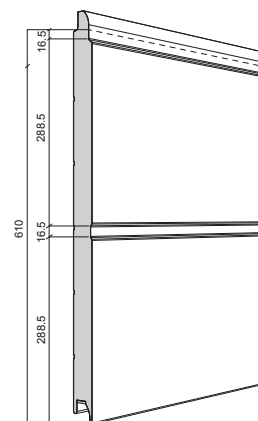

Pannello  
H 610

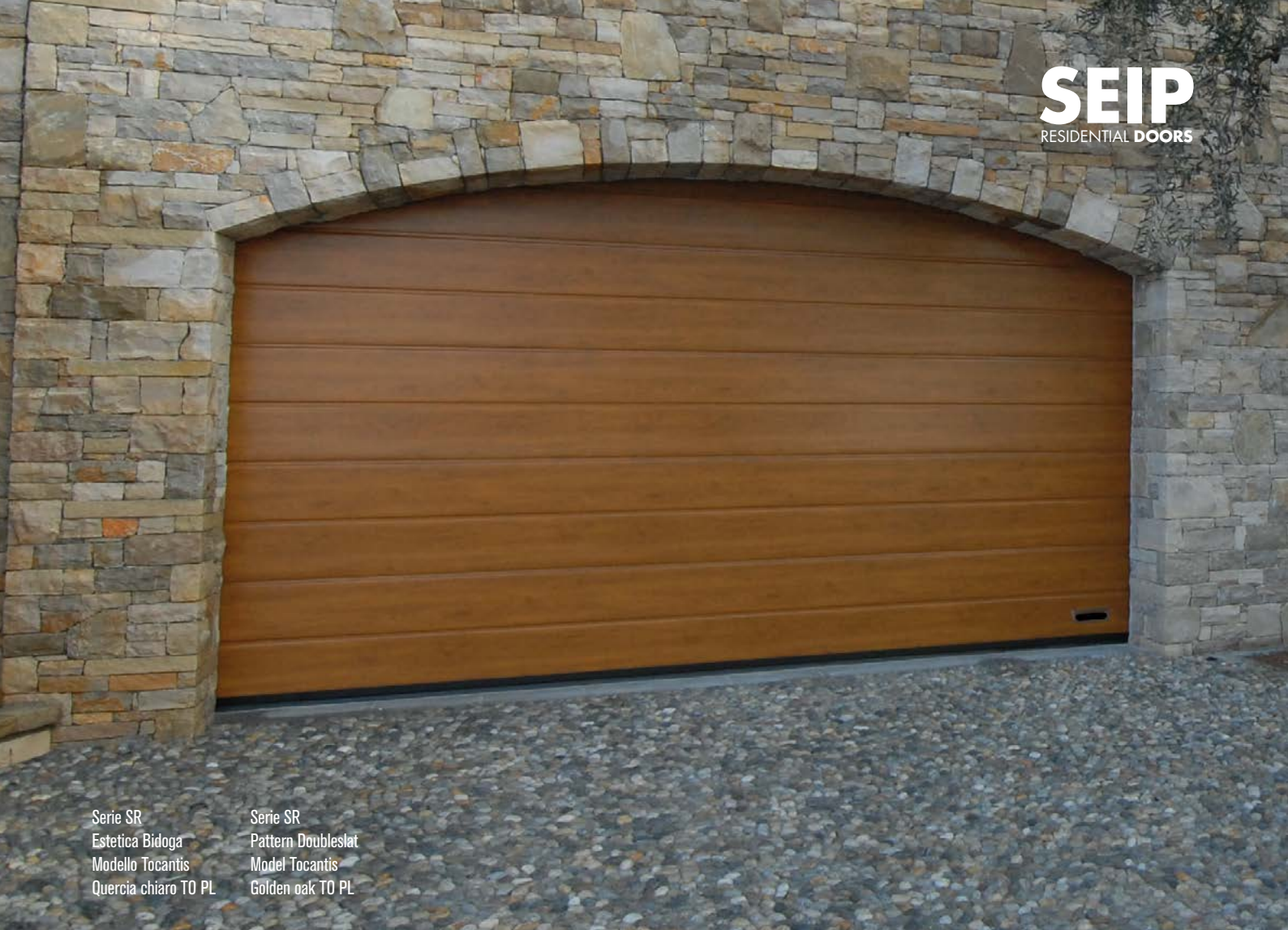

Serie SR  
Estetica Bidoga  
Modello Tocantis  
Quercia chiaro TO PL

Serie SR  
Pattern Doubleslat  
Model Tocantis  
Golden oak TO PL

## MODELLO / MODEL TOCANTINS

Questo modello riproduce fedelmente l'effetto del legno con il vantaggio di un'estetica pregiata senza bisogno di manutenzione nel tempo.

This model accurately reproduces the wood effect creating a refined appearance without the need of maintenance.

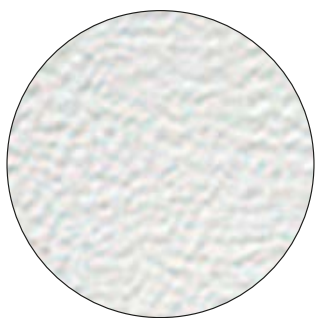

Finitura interna  
Goffrato stucco  
Ral 9010

Internal finishing  
Embossed succo  
Ral 9010

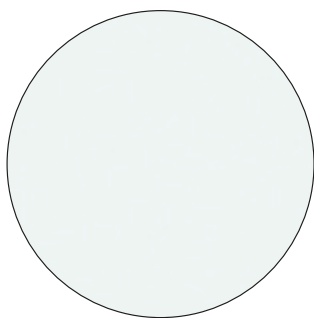

Finitura esterna  
Liscio

External finishing  
Smooth



TO RC  
ROVERE SBIANCATO  
WHITENED OAK



TO PQ  
QUERCIA CHIARO  
LIGHT OAK



TO PL  
QUERCIA SCURO  
DARK OAK



Serie SR  
Estetica Bidoga  
Modello Goias  
Ral 9010 GO BI

Serie SR  
Pattern Doubleslat  
Model Goias  
Ral 9010 GO BI

## MODELLO / MODEL GOIAS

Stile classico e rigoroso esaltato dalla finitura gofrata e venatura in rialzo ad effetto legnoso.

Traditional and rigorous style enhanced by the embossed finishing and the grains, which create a wooden effect.



Finitura interna  
Goffrato stucco  
Ral 9010

Internal embossed  
Stucco finish  
Ral 9010



Finitura esterna  
Goffrato legno

External finishing  
Wood grain



GO BI  
RAL 9010



GO VD  
RAL 6005



GO MR  
RAL 8014



TINTE RAL A RICHIESTA  
RAL COLOURS ON REQUEST



Serie SR  
Estetica Bidoga  
Modello San Paolo  
Tinte Ral 6028  
a richiesta

Serie SR  
Pattern Doublelat  
Model San Paolo  
Ral 6028 colours  
on request

## MODELLO / MODEL SAO PAULO

La perfetta unione tra la moderna eleganza della finitura liscia e la ricercatezza classica della grande scanalatura centrale di ogni pannello lo rendono adatto ad applicazioni nei più svariati contesti architettonici.

The perfect combination of the modern elegance of the smooth surface and the sophisticated large central slat of each panel make it perfect for various architectural contexts.

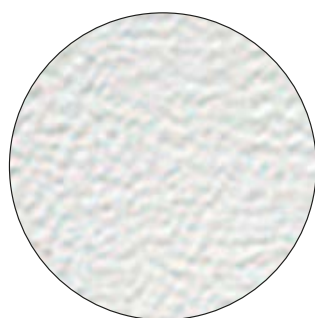

Finitura interna  
Goffrato stucco  
Ral 9010  
  
Internal embossed  
Stucco finish  
Ral 9010

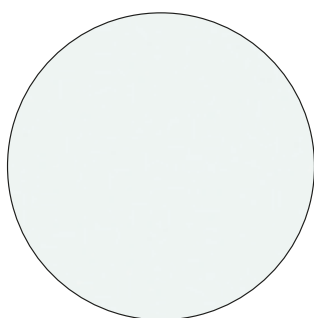

Finitura esterna  
Liscio  
  
External finishing  
Smooth

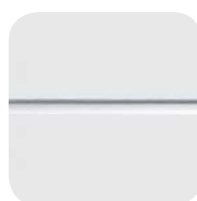

SP AR  
RAL 9006



SP BI  
RAL 9010



SP GA  
RAL 7016



TINTE RAL A RICHIESTA  
RAL COLOURS ON REQUEST

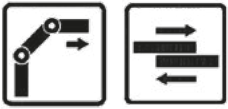

**SERIE SR-SRV-SLD-SLS**  
**SR-SRV-SLD-SLS SERIES**

# ESTETICA PIANA

# PLANAR PATTERN



Serie SR  
Estetica Piana  
Modello Rondonia  
Ral 9006 RO AR

Serie SR  
Pattern Planar  
Model Rondonia  
Ral 9006 RO AR

L'assenza di doghe e la finitura liscia o gofrata fanno di questa serie la più moderna e tecnologica.

The absence of slats and the smooth or embossed finishing make this model the most modern and technological one.

Pannello coibentato in acciaio zincato spessore 0,6 con verniciatura idonea per una collocazione esterna e atta a garantire la massima durata nel tempo.

Insulated panel made of galvanised steel, 0,6 mm thickness with a special painting suitable for external installation and perfect to ensure the best duration in time.

VISTA ESTERNA  
EXTERNAL VIEW

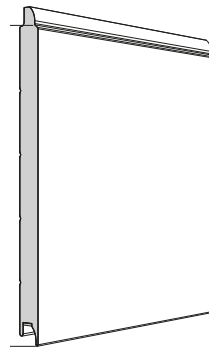

VISTA INTERNA  
INTERNAL VIEW

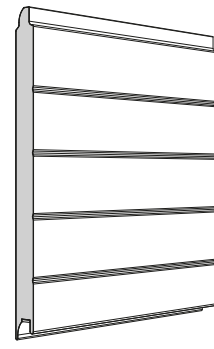

Pannello  
H 500

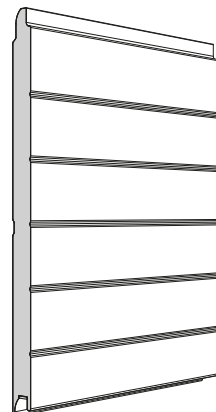
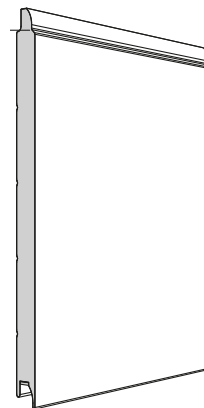

Pannello  
H 610

**SEIP**  
RESIDENTIAL DOORS

Pannello H 610 disponibile solo per modelli Bahia BA BI e Rondonia GP (Polygrain) RAL 7016  
Panel H 610 available only for Bahia BA BI and Rondonia GP (Polygrain) RAL 7016 models



Serie SR  
Estetica Piana  
Modello Rondonia  
Corten RO CO

Serie SR  
Pattern Planar  
Model Rondonia  
Corten RO CO

## MODELLO / MODEL **RONDONIA**

Eleganza e semplicità sulla superficie liscia disponibile in tutta la gamma RAL adatto per l'inserimento in contesti moderni e rigorosi.

Elegance and simplicity on the smooth surface available for the entire RAL series, perfect for modern and rigorous contexts.

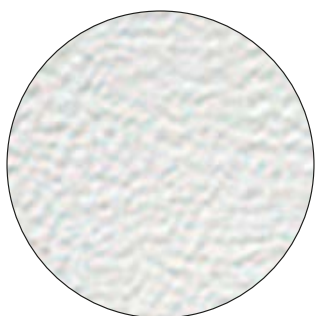

Finitura interna  
Goffrato stucco  
Ral 9010

Internal embossed  
Stucco finish  
Ral 9010

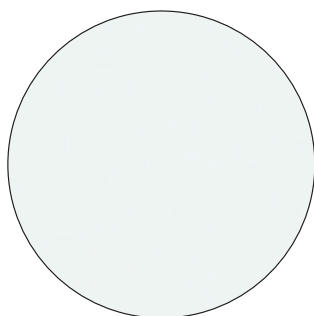

Finitura esterna  
Liscio

External finishing  
Smooth

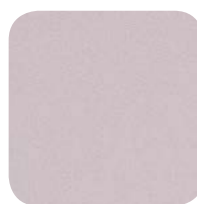

RO BI  
RAL 9010

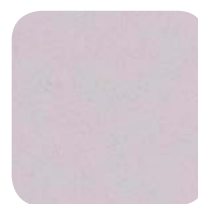

RO BP  
POLIGRAIN RAL 9010



RO GP  
RAL 7016



RO AR  
RAL 9006



RO CO  
CORTEN



RO PE  
RAL 1013



RO GI  
IRON SIMIL RAL 9006



RO IR  
IRON SIMIL RAL 9016



TINTE RAL A RICHIESTA  
RAL COLOURS  
ON REQUEST



Serie SR  
Estetica Piana  
Modello Bahia  
Ral a scelta

Serie SR  
Pattern Planar  
Model Bahia  
Ral colours on request

## MODELLO / MODEL **BAHIA**

L'assenza di doghe unita alla finitura gofrata donano alla porta uno stile semplice e moderno.

The absence of slats combined with the embossed finishing give the door a simple and modern style.



Finitura interna  
Goffrato stucco  
Ral 9010

Internal finishing  
Embossed stucco  
Ral 9010



Finitura esterna  
Goffrato legno

External finishing  
Wood grain



BABI  
RAL 9010



BA VR  
RAL 6009



BA MR  
RAL 8014



TINTE RAL A RICHIESTA  
RAL COLOURS ON REQUEST





Serie SR  
Estetica Piana  
Modello Amazonas  
Quercia chiaro AM PL

Serie SR  
Pattern Planar  
Model Amazonas  
Golden Oak AM PL

## MODELLO / MODEL AMAZONAS

La perfetta combinazione tra l'effetto legno e la finitura liscia del pannello creano eleganza e modernità allo stesso tempo.

The perfect combination of the wood effect and the smooth finish of the panel create elegance and modernity at the same time.

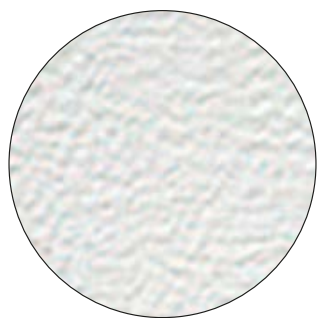

Finitura interna  
Goffrato stucco  
Ral 9010  
  
Internal finishing  
Embossed succo  
Ral 9010

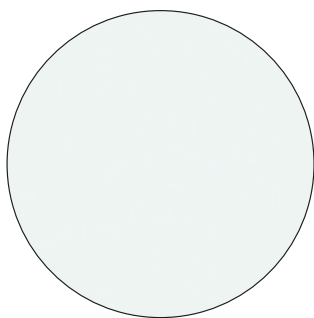

Finitura esterna  
Liscio  
  
External finishing  
Smooth



AM PL  
QUERCIA CHIARO  
LIGHT OAK



AM PQ  
QUERCIA SCURO  
DARK OAK

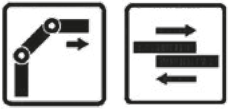

**SERIE SR-SRV-SLD-SLS**  
**SR-SRV-SLD-SLS SERIES**

# ESTETICA MULTIDOGA MULTISLAT PATTERN

Serie SR  
Estetica Multidoga  
Modello Sergipe  
Quercia chiaro SE PL

Serie SR  
Pattern Multislat  
Model Sergipe  
Golden Oak SE PL



Espressione di una sobria eleganza disponibile nella finitura liscia o nella finitura gofrata legno.

It is the expression of sober elegance, available with a smooth finishing or with an embossed wood one.

Pannello coibentato in acciaio zincato spessore 0,5 con verniciatura idonea per una collocazione esterna e atta a garantire la massima durata nel tempo.

Insulated panel made of galvanised steel, 0,5 mm thickness with a special painting suitable for external installation and perfect to ensure the best duration in time.

VISTA ESTERNA  
EXTERNAL VIEW

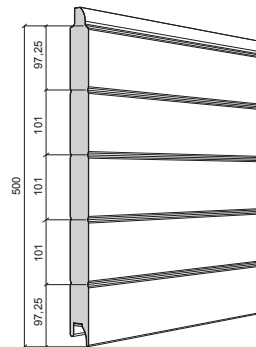

VISTA INTERNA  
INTERNAL VIEW

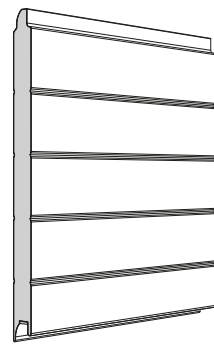

Pannello  
H 500

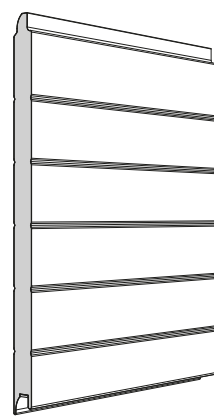
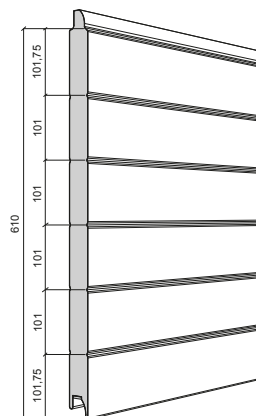

Pannello  
H 610

**SEIP**  
RESIDENTIAL DOORS

Pannello H 610 disponibile solo per modello Paranà PA AR e PA BI  
Panel H 610 available only for Paranà PA AR e PA BI model



Serie SR  
Estetica Multidoga  
Modello Sergipe  
Quercia chiaro SE PL

Serie SR  
Pattern Multislat  
Model Sergipe  
Light Oak SE PL

## MODELLO / MODEL SERGIPE

Il fascino dell'effetto legno sulla superficie liscia a doghe, inalterabile nel tempo.

The elegance of the wood effect on a smooth surface with slats, which cannot be altered in time.

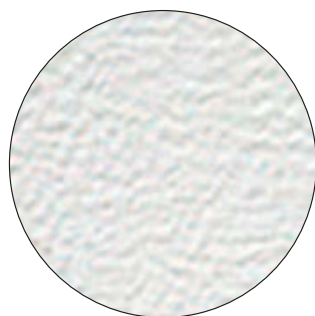

Finitura interna  
Goffrato stucco  
Ral 9010

Internal finishing  
Embossed succo  
Ral 9010

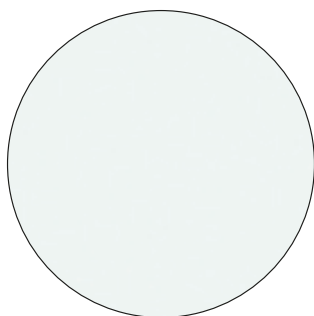

Finitura esterna  
Liscio

External finishing  
Smooth



SE PL  
QUERCIA CHIARO  
LIGHT OAK



SE PQ  
QUERCIA SCURO  
DARK OAK



Serie SR  
Estetica Multidoga  
Modello Paraná  
Tinte Ral 3003  
a richiesta

Serie SR  
Pattern Multislat  
Model Paraná  
Ral 3003 colours  
on request

## MODELLO / MODEL PARANÀ

Finitura gofrata ad effetto legno per un risultato che esprime essenzialità e rigore; disponibile in tutta la gamma RAL.

Embossed finishing with wooden effect for a result which is the expression of minimalism and precision; available in all RAL colours.

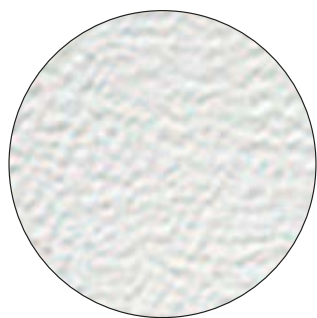

Finitura interna  
Goffrato stucco  
Ral 9010

Internal finishing  
Embossed stucco  
Ral 9010



Finitura esterna  
Goffrato legno

External finishing  
Wood grain



PA BI  
RAL 9010



PA AR  
RAL 9006



PA BG  
RAL 9002



TINTE RAL A RICHIESTA  
RAL COLOURS ON REQUEST



Serie SR  
Estetica Multidoga  
Modello Amapà  
Ral 9006 AP AR

Serie SR  
Pattern Multislat  
Model Amapà  
Ral 9006 AP AR

## MODELLO / MODEL AMAPÀ

Moderna combinazione di linee che esaltano l'essenzialità di un modello adatto ad inserirsi perfettamente in contesti di diverso stile architettonico.

Modern combination of lines which enhances the minimalism of a model which is perfect for various architectural contexts

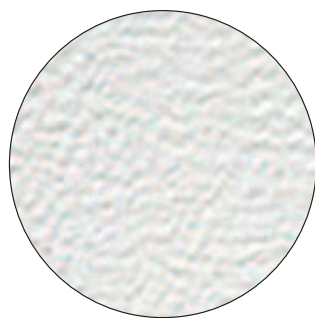

Finitura interna  
Goffrato stucco  
Ral 9010

Internal finishing  
Embossed succo  
Ral 9010

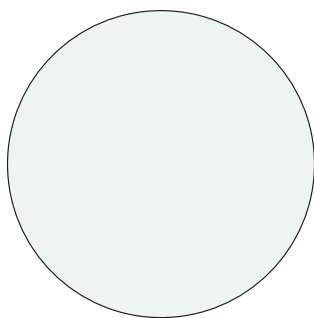

Finitura esterna  
Liscio

External finishing  
Smooth



AP AR  
RAL 9006



TINTE RAL A RICHIESTA  
RAL COLOURS ON REQUEST



**SERIE SR-SRV**  
**SR-SRV SERIES**

# ESTETICA VENEZIANA VENETIAN PATTERN



Unico ed esclusivo per rendere l'abitazione dove viene inserita la porta di forte personalità.

Unique and exclusive to give a house a strong personality.

Pannello coibentato in acciaio zincato spessore 0,5 con verniciatura idonea per una collocazione esterna e atta a garantire la massima durata nel tempo.

Insulated panel made of galvanised steel, 0,5 mm thickness with a special painting suitable for external installation and perfect to ensure the best duration in time.

VISTA ESTERNA  
EXTERNAL VIEW

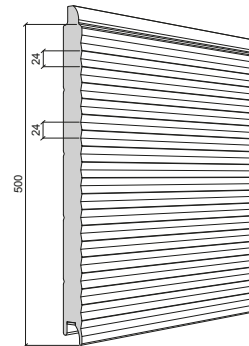

VISTA INTERNA  
INTERNAL VIEW

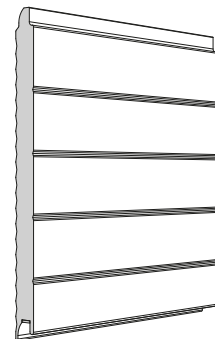

Pannello  
H 500

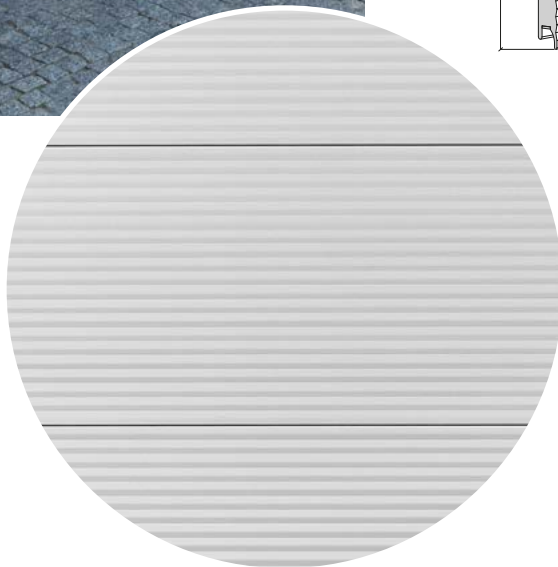

Serie SR  
Estetica Veneziana  
Modello Parà  
Ral 9010 PP BI

Serie SR  
Venetian Pattern  
Model Parà  
Ral 9010 PP BI

**SEIP**  
RESIDENTIAL DOORS



Serie SR  
Estetica Veneziana  
Modello Parà  
Ral 9006 PP AR

Serie SR  
Venetian Pattern  
Model Parà  
Ral 9006 PP AR

## MODELLO / MODEL **PARÀ**

Un pannello brevettato prodotto in esclusiva per SILVELOX che riporta micro doghe orizzontali creando un inconfondibile effetto veneziana.

A patented model exclusively produced for SILVELOX with macro horizontal slats that create an unmistakable venetian blind effect.

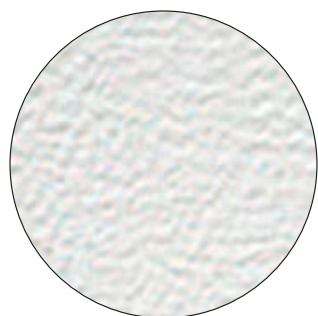

Finitura interna  
Goffrato stucco  
Ral 9010  
Internal finishing  
Embossed stucco  
Ral 9010

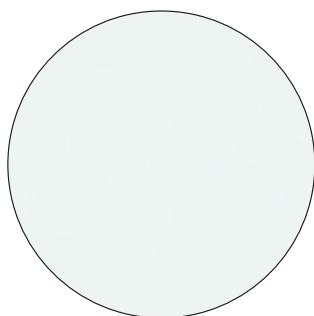

Finitura esterna  
Liscio  
External finishing  
Smooth



PP BI  
RAL 9010



PP AR  
RAL 9006



TINTE RAL A RICHIESTA  
RAL COLOURS  
ON REQUEST



**SERIE SR-SRV**  
**SR-SRV SERIES**

# ESTETICA CASSETTATA

# CAISSONED PATTERN

Serie SR  
Estetica Cassettata  
Modello Alagoas  
AL BI

Serie SR  
Caissoned Pattern  
Model Alagoas  
AL BI



Stile tradizionale che riprende la ricerca del particolare e dell'artigianalità tipica del legno.

Traditional style which recalls the research for details and the handmade quality which is typical of wood.

Pannello coibentato in acciaio zincato spessore 0,5 con verniciatura idonea per una collocazione esterna e atta a garantire la massima durata nel tempo.

Insulated panel made of galvanised steel, 0,5 mm thickness with a special painting suitable for external installation and perfect to ensure the best duration in time.

VISTA ESTERNA  
EXTERNAL VIEW

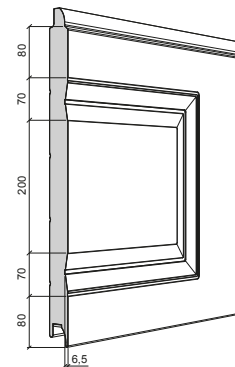

VISTA INTERNA  
INTERNAL VIEW

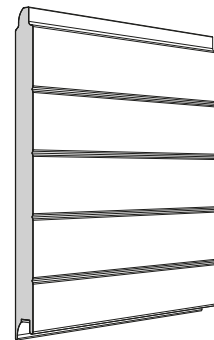

Pannello  
H 500





Serie SR  
Estetica Cassettata  
Modello Alagoas  
AL BI

Serie SR  
Caissoned Pattern  
Model Alagoas  
AL BI

## MODELLO / MODEL **ALAGOAS**

Modello di forte personalità grazie alle impronte cassetate che donano alla porta un carattere deciso.  
Disponibile nella finitura gofrata legno.

A model with a strong personality obtained thanks to the caissoned design which gives the door grandeur.  
Available in wood grain finiture.

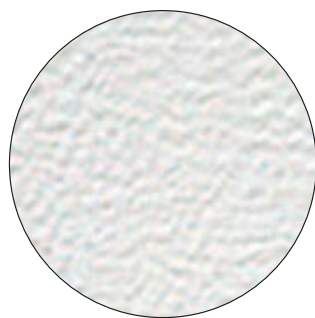

Finitura interna  
Goffrato stucco  
Ral 9010

Internal finishing  
Embossed stucco  
Ral 9010



Finitura esterna  
Goffrato legno

External finishing  
Wood grain



AL BI  
RAL 9010



TINTE RAL A RICHIESTA  
RAL COLOURS ON REQUEST



Serie SR  
Estetica multidoga verticale  
Modello Madeira3  
Noce

Serie SR  
Vertical multislát pattern  
Model Madeira3  
Walnut

# MADEIRA LA PORTA DA GARAGE ELEGANTE E RAFFINATA IN LEGNO

# MADEIRA THE GARAGE DOOR ELEGANT AND REFINED IN WOOD



Il modello Madeira viene realizzato nella versione sezionale residenziale oppure a scorrimento laterale singolo o doppio. Sono composti da pannelli di spessore 40 mm realizzati in legno marino di okoumè, un pregiato legno idrorepellente e leggero.

La versione sezionale può essere realizzata fino a larghezze di 4,8 m ed altezze di 3,1 m.

La versione porta laterale singola può essere realizzata fino a larghezza di 6 m ed altezza massima di 3,25 m.

La versione porta laterale doppia può essere realizzata fino a larghezza di 12 m ed altezza massima di 3,25 m.

Essendo un prodotto di design, sono state create tre eleganti estetiche, ognuna realizzabile in tredici diverse tinte.

Per esaltarne il pregio ed elevare la nobiltà del manto, la porta viene fornita con gli accessori del manto di colore nero. Su richiesta, sono disponibili altri optional per impreziosire il prodotto, come oblò realizzati in legno con tamponamento in policarbonato o vetro antisfondamento.

The Madeira model is produced in the residential sectional version or with single or double lateral scrolling. They are composed of 40 mm thick panels made of okoumè marine wood, a precious water-repellent and light wood.

The sectional version can be made up to widths of 4.8 m and heights of 3.1 m.

The single side door version can be made up to a width of 6 m and a maximum height of 3.25 m.

The double side door version can be made up to a width of 12 m and a maximum height of 3.25 m.

Being a design product, three elegant aesthetics have been created, each achievable in thirteen different colors.

To enhance its value and raise the nobility of the door, the door is supplied with black door accessories. On request, other optionals are available to embellish the product, such as portholes made of wood with polycarbonate infill or shatterproof glass.

ESTETICA PIANA SERIE SR  
PLANAR PATTERN SR SERIES  
**MADEIRA1**

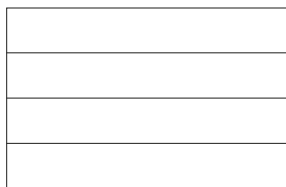

ESTETICA QUADRA  
SQUARE PATTERN  
**MADEIRA2**

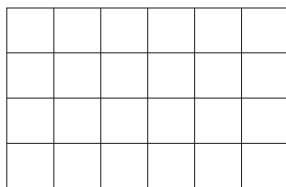

ESTETICA MULTIDOGA VERTICALE  
VERTICAL MULTISLAT PATTERN  
**MADEIRA3**

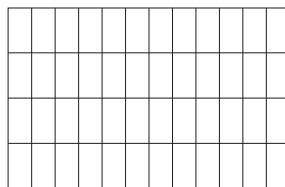

ESTETICA PIANA SERIE SLS - SLD  
PLANAR PATTERN SLS - SLD SERIES  
**MADEIRA4**

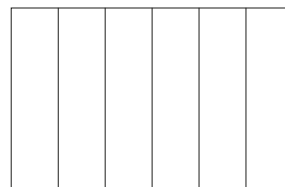

Disponibile fino a larghezze di 3,1 m.  
Altre estetiche personalizzate a richiesta  
e fattibilità ufficio tecnico  
Available up to 3.1 m width  
Other customized aesthetics on request  
and upon technical office feasibility

## FINITURE ED ACCESSORI / FINISHES AND ACCESSORIES

### TINTE DISPONIBILI LEGNO / AVAILABLE WOODEN COLOURS



MIELE  
HONEY



ROVERE  
OAK



DOUGLAS  
DOUGLAS

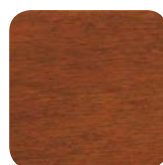

CILIGIO  
CHERRY

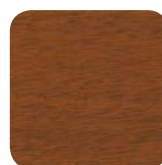

MOGANO  
MAHOGANY

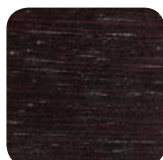

WENGÈ  
WENGÈ

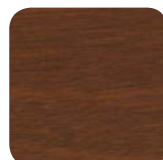

NOCE  
WALNUT

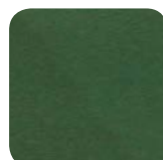

VERDE  
GREEN

### TINTE DISPONIBILI LACCATE / AVAILABLE LAQUERED COLOURS



RAL 6005  
VERDE MUSCHIO  
MOSS GREEN



RAL 6009  
VERDE ABETE  
FIR GREEN



RAL 7016  
GRIGIO ANTRACITE  
ANTHRACITE GRAY

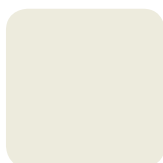

RAL 9002  
BIANCO GRIGIO  
GREY WHITE



RAL 9006  
ALLUMINIO BRILLANTE  
BRIGHT ALUMINUM

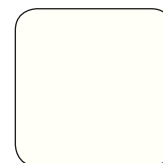

RAL 9010  
BIANCO PURO  
PURE WHITE

## OBLÒ / WINDOWS



Vista esterna  
External View

Sono disponibili su richiesta pregiati oblò  
in legno con tamponamento di 6 mm  
in policarbonato  
o vetro antisfondamento.  
High-quality wooden windows with 6 mm  
polycarbonate or shatterproof glass  
are available on request.



Accessori di colore nero conferiscono eleganza alla parte interna del  
manto, rendendolo a tutti gli effetti un elemento di design.  
Accessories in black colour give elegance to the internal side of the  
mantle, making it a design element.



**SERIE SLD-SLS**  
**SLD-SLS SERIES**

**SEIP**  
RESIDENTIAL DOORS

# PORTE SEZIONALI SCORRIMENTO LATERALE SECTIONAL DOORS WITH LATERAL SLIDING

ANCHE NELLA VERSIONE IN LEGNO  
ALSO IN THE WOODEN VERSION

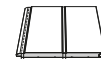

ESTETICA BIDOGA  
DOUBLESLAT PATTERN

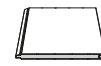

ESTETICA PIANA  
PLANAR PATTERN



ESTETICA MULTIDOGA  
MULTISLAT PATTERN

Serie SLD  
Estetica Multidoga  
Modello Tocantis  
Pannello in Okoumé  
laccato Ral 6005

Serie SLD  
Multislat pattern  
Model Tocantis  
Okoumé panel  
lacquered Ral 6005



SLS e SLD sono le porte ideali in situazioni in cui è necessario eliminare l'ingombro in architrave.

## PANNELLI

Sono disponibili due soluzioni di pannelli:

- Pannello coibentato in acciaio zincato.
- Pannelli spessore 40 mm, realizzate in legno marino di Okoumé nelle finiture tinte legno.

## MECCANICA

La parte meccanica di movimentazione prevede lo scorrimento dei pannelli per mezzo di una guida ad architrave senza l'utilizzo di carrelli a pavimento.

La chiusura ermetica della porta è garantita da un mix di guarnizioni in gomma e spazzole su tutto il perimetro.

SLS and SLD are the best doors when it is necessary to reduce the space on the lintel.

## PANELS

Two panel solutions are available:

- Insulated panel in galvanized steel.
- 40 mm thick panels, made of marine wood of Okoumé in wood-colored finishes.

## FUNCTIONING

The panels slide thanks to a lintel rail that does not need floor carriages. The hermetic closure of the door is guaranteed by a combination of rubber seals and brushes on the entire perimeter.





**SERIE SLD - SLS**  
**SLD-SLS SERIES**

# PORTE SEZIONALI SCORRIMENTO LATERALE SECTIONAL DOORS WITH LATERAL SLIDING



Incontro a pavimento: è prevista una soglia ribassata che non ostacola il passaggio.

Floor guide: There is a low threshold which doesn't obstruct the passage.

Nuova ed esclusiva intelaiatura perimetrale in alluminio con spazzolini per una maggiore coibentazione della porta.

New and exclusive perimeter aluminum frame equipped with brushes for a better thermal insulation.



## PORTA LATERALE SINGOLA SLS

Larghezza massima realizzabile  
L = 6 m ed altezza massima  
H = 3,25 m.

## LATERAL SINGLE DOOR SLS

Dimensions: maximum width  
maximum width W = 6 m  
maximum height H = 3.25 m



PORTA LATERALE DOPPIA SLD - Larghezza massima realizzabile L = 12 m ed altezza massima H = 3,25 m.

LATERAL DOUBLE DOOR SLD - Dimensions: maximum width W = 12 m and maximum height H = 3.25 m



**SERIE PL**  
**PL SERIES**

**SEIP**  
RESIDENTIAL DOORS

# PORTA PEDONALE PASSO-UOMO LATERALE LATERAL PEDESTRIAN DOOR

## PORTA PEDONALE LATERALE

Con telaio in alluminio verniciato, è prevista in dimensioni da 900 a 1200 mm di larghezza e da 2100 a 2500 mm di altezza, con telaio standard di colore nero. Su richiesta è possibile avere dimensioni e colore del telaio speciali. Le porte laterali sono realizzate con i medesimi pannelli delle porte sezionali. Il telaio perimetrale in caso di pannello effetto legno viene sublimato con lo stesso effetto legno. La porta pedonale laterale è disponibile anche sul modello Panorama grigliato, vetrato e due battenti. Sono disponibili accessori come maniglione antipanico, serrature elettriche e sopraluce vetrati.

## LATERAL PEDESTRIAN DOOR

With painted aluminum frame, it is available in different dimensions: from 900 to 1200 mm width and from 2100 to 2500 mm height, with standard black frame. Special dimensions and colours for the frame are available on request. Lateral doors are made with the same panels as sectional doors. The perimeter frame in case of wood effect panel provides with the same wood effect. The side door is also available on the model Panorama gridded, glazed and with double leaf. Accessories such as panic exit bars, electric locks and glazed transoms are available.

Serie SR  
Estetica Bidoga  
Modello San Paolo  
Ral 9006 SP AR

Serie SR  
Pattern Doubleslat  
Model San Paolo  
Ral 9006 SP AR

Esempio di realizzazione porta sezionale con porta laterale,  
possibilità di utilizzo su tutte le estetiche e modelli (estetica cassetata esclusa)  
Example of sectional door with lateral wicket door,  
available on any pattern and model (caissoned pattern excluded)



**VERSIONI SPECIALI**  
**SPECIAL VERSIONS**



# PORTA PEDONALE BREVETTATA PATENTED WICKET DOOR

Esempio di realizzazione porta sezionale con porta pedonale inserita, misure disponibili 800 - 900 -1200 mm in larghezza e possibilità di utilizzo su tutte le estetiche e modelli ad esclusione dell'estetica cassetata.

Le caratteristiche che la rendono preziosa:

- Cerniere a scomparsa inserite nei profili di alluminio di disegno Silvelox, silenziose e autolubrificanti
- Profili in alluminio senza rivetti esterni, con finitura che garantisce linearità e pulizia

Esiste la possibilità di adottare serrature a 3 o 5 punti di chiusura.

Example of realization of sectional door with pedestrian door inserted, available sizes W 800 - 900 -1200 mm, can be installed on all the aesthetics and models with the exception of boxed aesthetics.

Its main characteristics are:

- the hidden hinges inserted in the aluminum profiles, designed by Silvelox. They are silent and self-lubricating.
- the aluminum profiles without external rivets, with a linear and smooth finishing.

A new alternative closure with 3 or 5 locking points is now available.



Serie SR  
Estetica Bidoga  
Modello Tocantis  
Rovere sbiancato TO RC

Serie SR  
Doubleslat pattern  
Model Tocantis  
Bleched oak TO RC





PLANARITÀ PERFETTA  
PERFECT PLANARITY



Anti schiacciamento  
interno ed esterno.  
Internal and external finger  
protection system.



Disponibile pompa chiudiporta progettata in Germania che permette il blocco della porta aperta tramite una pratica leva.

Available door closer device designed in Germany that allows to block the door open using a practical leverage.



SOGLIA RIBASSATA 18 MM COMPRESO GUARNIZIONE  
LOWERED THRESHOLD 18 MM INCLUDING GASKET



Montaggio facile grazie alle particolari piastrelle di centraggio che garantiscono il perfetto allineamento dei profili.

Easy to install thanks to particular centering plates that guarantee the perfect alignment of the frames.



Per maggior sicurezza disponibile chiusura a 3 o 5 punti.

If more security is required 3 or 5 lock points latch is available



CHIAVI DI SICUREZZA  
SAFETY KEYS



MANIGLIA ERGONOMICA IN ALLUMINIO  
ERGONOMIC HANDLE IN ALUMINUM



**SERIE SP**  
SP SERIES

# SEZIONALE PANORAMA SERIE SP

# PANORAMA SECTIONAL SP SERIES

Il modello PANORAMA è disponibile nella variante VETRATA: il telaio in alluminio sostiene in questo caso sezioni in metacrilato o vetro, garantendo un elevato livello di luminosità. Si garantisce la possibilità di optare per soluzioni totalmente grigliate o vetrate, oppure un mix tra le due versioni, o ancora un mix tra i pannelli PANORAMA e i normali pannelli coibentati. Disponibile nei vari colori RAL o effetto legno. Le dimensioni massime sono **L = 6 m - H = 3,10 m**.

The Panorama Model is available in the GLAZED version: the aluminum case supports methacrylate or glass sections, ensuring a high quality level of natural light. It is possible to opt for solutions with grids, glass or a combination of the two versions, as well as a combinations of panorama and normal insulated panels. They are available in all RAL colours or wood effect. Maximum measures **W = 6 m - H = 3.10 m**.

Serie SP  
Estetica Panorama  
Modello Vetrato  
Ral 9010

Serie SP  
Panorama pattern  
Model Glazed  
Ral 9010



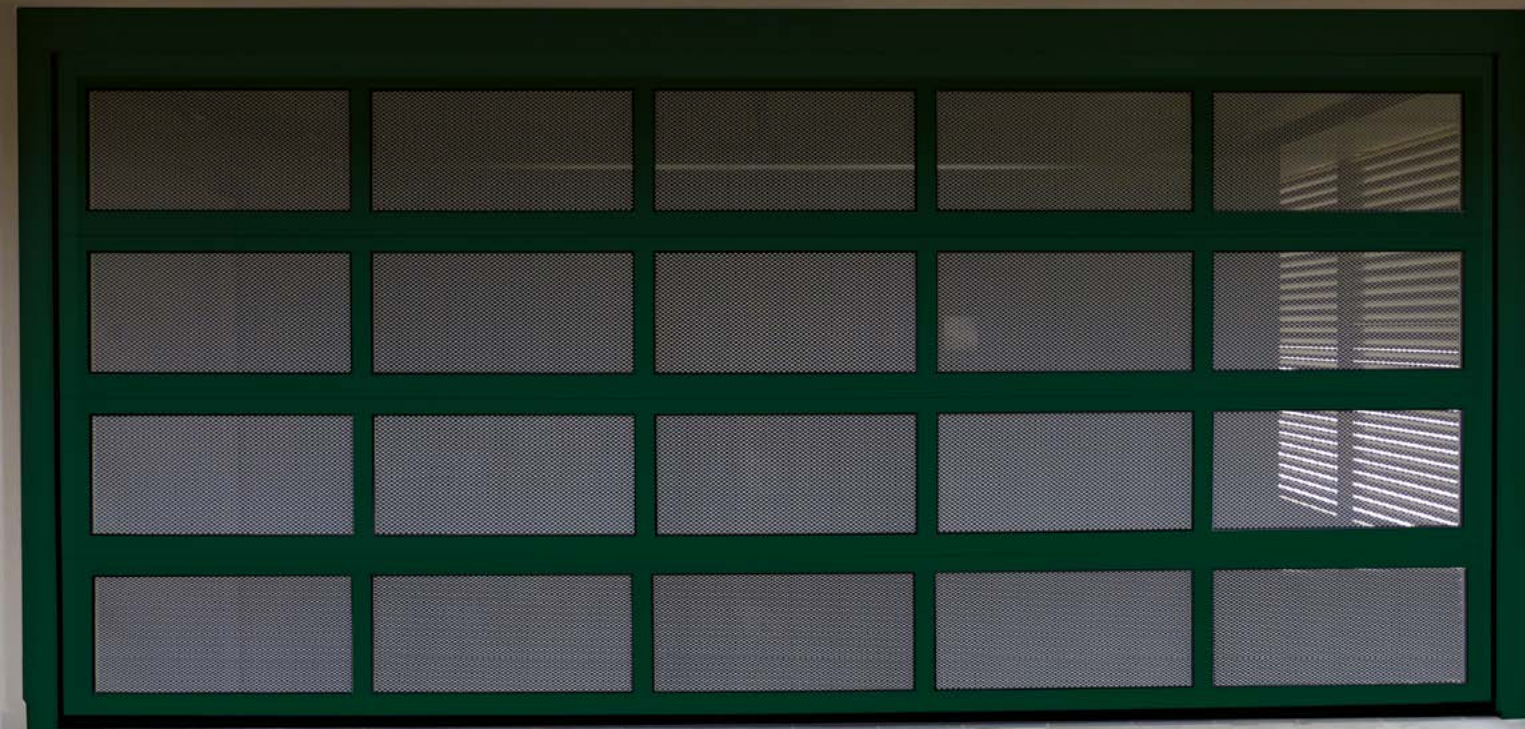

Serie SP  
Estetica Panorama  
Modello grigliato  
Ral 6005

Serie SP  
Panorama pattern  
Model grigliato  
Ral 6005

Esempio di realizzazione porta sezionale con inserti in alluminio tamponati con rete stirata.  
Possibilità di utilizzo su tutte le estetiche e modelli.  
Example of a sectional door with aluminum elements that hold a metal glazed net. Available for all models and aesthetics.

Qualora si necessiti di un elevato livello di aerazione, si propone il modello PANORAMA GRIGLIATO, dotato di griglie inserite nei telai in alluminio che costituiscono il pannello.  
Sono disponibili griglie con aerazione vuoto su pieno del 50% oppure dell'81%.

If a high level of air flow is needed, GRILLED PANORAMA is the best solution, being equipped with grids instead of the traditional panels. Grids are available with a 50% or 81% of open area for air passage.

## ESEMPI DI PORTE SEZIONALI CON INSERIMENTO DI PANNELLI PANORAMA EXAMPLES OF SECTIONAL DOORS WITH PANORAMA PANELS INSERTIONS

### SOLUZIONI DI TAMPONAMENTO DISPONIBILI:

Policarbonato trattato UV 3 mm trasparente o opale  
Policarbonato trattato UV in camera 3/12/3 opale o trasparente  
Policarbonato alveolare 16 mm  
Vetro 3+3 trasparente  
Rete con aerazione 67% e 50%

### AVAILABLE SOLUTIONS:

3 mm UV treated polycarbonate transparent or opal  
UV treated polycarbonate in 3/12/3 opal or transparent  
UV treated polycarbonate alveolar chamber or 16 mm  
3 + 3 transparent glass  
Mesh with ventilation 67% and 50%

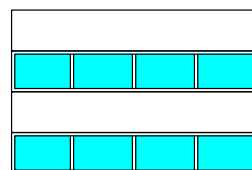
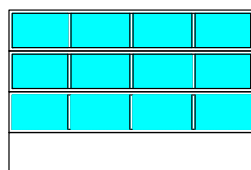
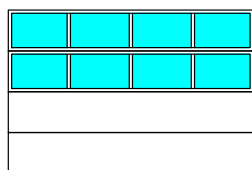
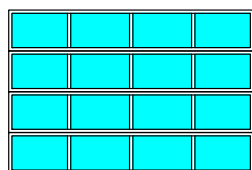
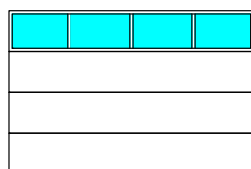
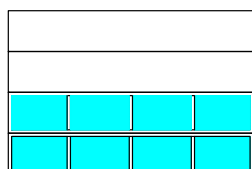

Possibilità di altre configurazioni contattando ufficio tecnico commerciale.  
Possibility of further configurations by contacting the technical sales office.

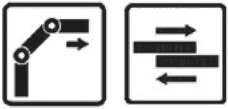

**SERIE SR-SRV-SLD-SLS**  
SR-SRV-SLD-SLS SERIES

# RIEPILOGO ESTETICHE E COLORI PATTERNS AND COLOURS SUMMARY

## ESTETICA PIANA | PLANAR PATTERN



## ESTETICA MULTIDOGA | MULTISLAT PATTERN



## ESTETICA VENEZIANA | VENETIAN PATTERN



PP BI

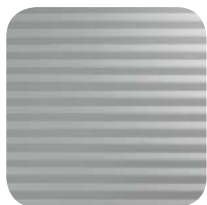

PP AR



TINTE RAL A RICHIESTA  
RAL COLOURS ON REQUEST



AL BI



TINTE RAL A RICHIESTA  
RAL COLOURS ON REQUEST

## ESTETICA BIDOGA | DOUBLES LAT PATTERN



SP BI



SP AR



SP GA



GO BI



GO VD



GO MR



TO RC



TO PL



TO PQ



TINTE RAL A RICHIESTA  
RAL COLOURS ON REQUEST

## FINITURE PANNELLI OKOUMÉ / OKOUMÉ PANEL FINISHES

### SERIE SR-SLD-SLS / SR-SLD-SLS SERIES

TINTE DISPONIBILI LEGNO / AVAILABLE WOODEN COLOURS

TINTE DISPONIBILI LEGNO / AVAILABLE WOODEN COLOURS



MIELE  
HONEY



ROVERE  
OAK



DOUGLAS  
DOUGLAS

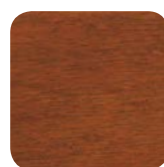

CILIEGIO  
CHERRY

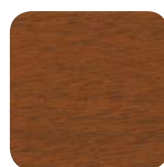

MOGANO  
MAHOGANY

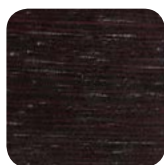

WENGÈ  
WENGÈ

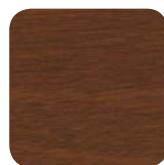

NOCE  
WALNUT

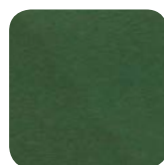

VERDE  
GREEN

TINTE DISPONIBILI LACCATE / AVAILABLE LAQUERED COLOURS



RAL 6005  
VERDE MUSCHIO  
MOSS GREEN



RAL 6009  
VERDE ABETE  
FIR GREEN



RAL 7016  
GRIGIO ANTRACITE  
ANTHRACITE GRAY



RAL 9002  
BIANCO GRIGIO  
GREY WHITE



RAL 9006  
ALLUMINIO BRILLANTE  
BRIGHT ALUMINUM

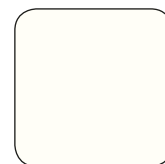

RAL 9010  
BIANCO PURO  
PURE WHITE

# ACCESSORI - MOTORIZZAZIONE

# ACCESSORIES - MOTORISATION

## OBLÒ E GRIGLIE DI AERAZIONE

## PORTHOLES AND AERATION GRIDS



Oblò rettangolare motivo legnoso colore esterno bianco o nero con inglesina dimensioni 322x488 mm interno bianco.  
**Rectangular porthole.**  
**Wood effect finish. Colour: black or white.**  
**Dimension 322x488 mm.**



Oblò antieffrazione nero.  
Dimensioni 146x609 mm.  
**Anti-burglary black porthole.**  
**Dimensions 146x609 mm.**



Oblò ovale nero interno ed esterno.  
Dimensioni 660x340 mm.  
**Oval porthole.**  
**Colour: internal and external black.**  
**Dimensions: 660x340 mm.**



Oblò rettangolare colore esterno simil legno quercia chiaro o quercia scuro, interno bianco. Dimensioni 324x490 mm.  
**Rectangular porthole.**  
**External colour: light or dark oak.**  
**Internal colour: white.**  
**Dimensions: 324x490 mm.**



Oblò rettangolare motivo legnoso colore esterno bianco o nero, interno bianco. Dimensioni 324x490 mm.  
**Rectangular porthole. Wood effect.**  
**External colour: black or white.**  
**Internal colour: white.**  
**Dimensions: 324x490 mm.**

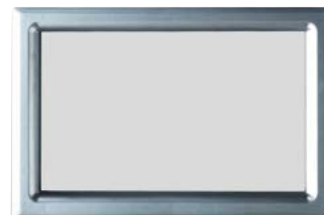

Oblò rettangolare colore esterno cromato, interno bianco. Dimensioni 324x490 mm.  
**Rectangular porthole.**  
**External colour: chrome.**  
**Internal colour: white.**  
**Dimensions: 324x490 mm.**



Oblò rettangolare finitura liscia colore esterno bianco, interno bianco. Dimensioni 364x530 mm.  
**Rectangular porthole. Smooth finish.**  
**External colour: white.**  
**Dimensions: 364x530 mm.**



Oblò rettangolare finitura liscia colore esterno grigio RAL 7016 interno bianco. Dimensioni 364x530 mm.  
**Rectangular porthole. Smooth finish.**  
**External colour: grey RAL 7016.**  
**Internal colour: white.**  
**Dimensions: 364x530 mm.**



Oblò tondo.  
Diametro 330 mm.  
**Round porthole.**  
**Diameter 330 mm.**



Oblò quadrato cornice esterno ALLUMINIO SPAZZOLATO, interno bianco con vetro opaco di sicurezza 3+3 mm.  
 Dimensioni 290x290 mm.  
**Square porthole.**  
**External colour: BRUSHED ALUMINUM.**  
**Internal colour: white.**  
**Opaque safety glass 3 + 3 mm.**  
**Dimensions: 290x290 mm.**



Oblò quadrato colore esterno quercia chiaro, interno bianco con tamponamento esterno trasparente in APET e interno opaco in CIPET dimensioni 290x290 mm o con vetro esterno di sicurezza 3+3 mm.  
**Square porthole, external colour: light oak.**  
**Internal colour: white.**  
**External finish in APET and opaque internal finish in CIPET.**  
**Dimensions 290x290 mm.**  
**Security glass 3+3 mm available.**



Oblò quadrato colore esterno quercia scuro, interno bianco con tamponamento esterno trasparente in APET e interno opaco in CIPET dimensioni 290x290 mm o con vetro esterno di sicurezza 3+3 mm.  
**Square porthole, external colour: light oak.**  
**Internal colour: white.**  
**External finish in APET and opaque internal finish in CIPET.**  
**Dimensions 290x290 mm.**  
**Security glass 3+3 mm available.**



Griglia di aerazione bianca o nera.  
 Dimensioni 132x338 mm.  
**Aeration grid. Colours: black or white.**  
**Dimensions: 132x338 mm.**



Guide verniciate bianco RAL 9016, da richiedere espressamente in fase d'ordine: migliorano l'aspetto estetico della porta vista internamente.  
**White RAL 9016 guides, to be required when ordering: improves the internal aesthetic of the door.**



Veletta di aereazione grigliata che sostituisce il tubolare in architrave, realizzata in ferro verniciato RAL 9010 o in tinte RAL a richiesta.  
**Aeration metal grid for replacing the tubular lintel.**  
**Colours: painted RAL9010 or other RAL on request.**



Maniglia con pomolo esterno nera per porte manuali o come sblocco motore nel caso di porte motorizzate.  
**External black handle for manual doors or used as unlocking device for motorized doors.**

## ACCESSORI ELETTRONICI ELECTRONIC ACCESSORIES



### DISPOSITIVO ELETTRONICO MT600 MT600 ELECTRONIC DEVICE

MT600 è il dispositivo elettronico che consente l'azionamento di un cancello o una porta da garage, utilizzando uno smartphone. MT600 è in grado di copiare il radiocomando di una automazione e quindi di controllarla comportandosi come un radiocomando. Può essere utilizzato installato fisso all'esterno del proprio portone o può essere portato con se in auto e memorizzare fino a 4 chiusure in luoghi differenti.

Il dispositivo si collega allo smartphone con connessione Bluetooth 4 LE. Compatibile con il 90% dei telecomandi a codifica fissa e rolling code. Controlla fino a 4 chiusure (cancelli, porte per garage, etc).

MT600 is the electronic device that allows the operation of a gate or a garage door by using the smartphone.

MT600 is able to copy the remote control of an automation and therefore to control it by behaving like a radio control.

It can be installed outside your door or it can be taken with you in the car and store up to 4 locks in different places.

The device connects to the smartphone with Bluetooth 4 LE connection. Compatible with 90% of fixed and rolling code remote controls. Control up to 4 locks (gates, garage doors, etc).



### APP SILVELOX

App dedicata al cliente finale per l'apertura della porta tramite smartphone.

Module for automation control from smartphone.

## MOTORIZZAZIONE MOTORIZATION

Motore elettrico HALO 24Vdc a profilo ribassato, adatto per portoni basculanti fino a 14 m<sup>2</sup> e sezionali fino a 16 m<sup>2</sup>. Dotato di encoder, centrale di comando e ricevitore a 4 canali guida preassemblata a cinghia o catena, in pezzo unico o 3 pezzi. Dotato di speciale guida in alluminio di serie, verniciata a polveri con led integrati, permette l'illuminazione del garage sia durante la movimentazione che in qualsiasi altro momento. Conformazione appiattita del corpo motore. Disponibile anche con guida zincata.

HALO 24Vdc electric motor with low profile, suitable for overhead doors up to 14 m<sup>2</sup> and sectional doors up to 16 m<sup>2</sup>. Equipped with encoder, control unit and 4-channel preassembled guide with belt or chain, in one piece or 3 pieces. Equipped with a powder painted standard aluminium guide with LED, allows the lighting inside the garage during the operation of the door as well as in any other moment. Flattened shape of the motor body. available Also with galvanized guides.







Selettore HALO con tastierino numerico. Selettore digitale via radio da abbinare a tutti i ricevitori rolling code con batterie incluse.

**HALO selector with numeric keypad. Digital radio selector to combine with all rolling code receivers with batteries included.**



Apertura e chiusura della porta attraverso il cellulare oppure con radiocomando XR Rolling Code e XR Rolling Code con ricevente e bordo, IP68 resistente all'acqua 4 canali 433 MHz. Semplice, funzionale, ergonomico. Diverse colorazioni intercambiabili.

**Opening and closing the door through the mobile phone or with XR Rolling Code radio transmitter with receiver and edge, IP68 water-proof, 4 channels, 433MHz. Easy use, functional, ergonomic. Different interchangeable colors.**



1. Centrale domotica di comando miniaturizzata. Programmazione con LED+BUZZER. Memorizzazione di 30 trasmettitori. Spegnimento automatico. Punti di comando luci via cavo.

2. Trasmettitore da incasso 2 canali. Batteria al litio CR2032.

**1. Control unit with miniaturized control. Programming with LED + BUZZER. Storage of 30 transmitters. Automatic switch-off.**

**2. Cable lights control points. 2-channel built-in transmitter. CR2032 lithium battery.**



Telecomando touch un canale da incasso sul pannello della porta (fresata da 35 mm).

**Remote control with touch technology 1 channel for door panel recess.**

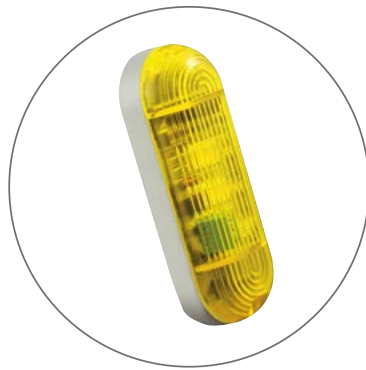

Lampeggiatore MICRO-FLASH con tecnologia LED.

**MICRO-FLASH flasher with LED technology.**



Telecomando touch 1 canale da parete.

**Remote control with touch technology 1 channel for wall.**



App. dedicata per il cliente per l'apertura della porta tramite smartphone.

**Dedicated app for the end user to open the gate by using the smartphone**

# STRUTTURE PORTANTI IN ALLUMINIO ALUMINUM STRUCTURES

Per garantire un buon impatto estetico ottenendo al tempo stesso maggiore facilità nelle movimentazioni e nelle lavorazioni, si propone tubolari per le spalle laterali e per l'architrave in alluminio con trattamento superficiale innovativo, che dona alla struttura lo stesso grado di finitura del pannello.

To ensure a great aesthetic impact, gaining at the same time ease in handling, aluminum tubular products to be fixed on the sides and on the lintel are proposed. Their surface has been treated with an innovative system that gives the structure the same accurate finishing as the sectional door.

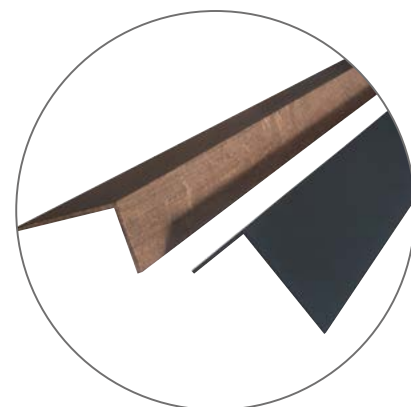

Disponibili coprifili di finitura 50x30 mm in tinta RAL e effetto legno. L-shape profil covers 50x30 mm painted in RAL or wooden effect.

Disponibili in tutte le finiture del catalogo pannelli, sia in tinta legno che tinte RAL della porta.

Misure spalla 100x30x2 mm

Misure architrave 150x30x1,5 mm

Available in all colours of the panel catalogue, wood effect or RAL.

Lateral measure 100x3x2 mm

Lintel measure 150x30x1,5 mm



Esempi di realizzazione con struttura in alluminio tinta RAL o effetto legno  
Samples of installations with aluminum structure, painted in RAL or wood effect.

# INGOMBRI E TIPI DI INSTALLAZIONE

# DIMENSIONS AND METHODS

# OF INSTALLATION

## SEZIONI VERTICALI SERIE SR

## VERTICAL SECTIONS SR SERIES

### VERSIONE | VERSION

### WA - WM

Scorrimento superiore con architrave 150 mm.  
Superior sliding with 150 mm lintel

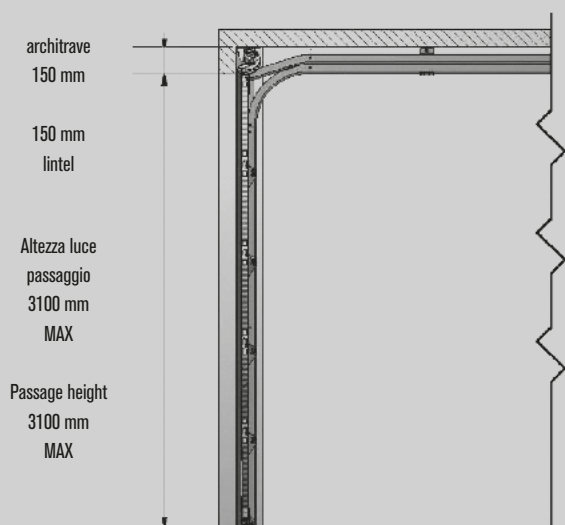

### VERSIONE | VERSION

### WB

Scorrimento superiore con architrave 250 mm.  
Superior sliding with 250 mm lintel

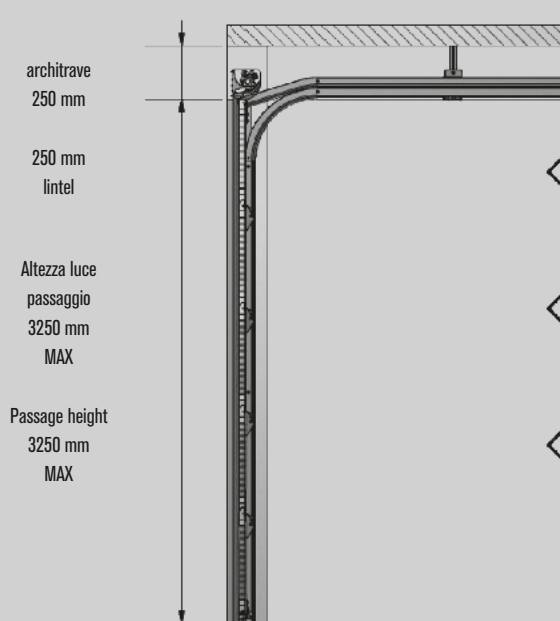

### VERSIONE | VERSION

### WC - WN

Scorrimento superiore inclinato con architrave 150 mm MAX 12°  
Superior sliding with 150 mm lintel max 12°

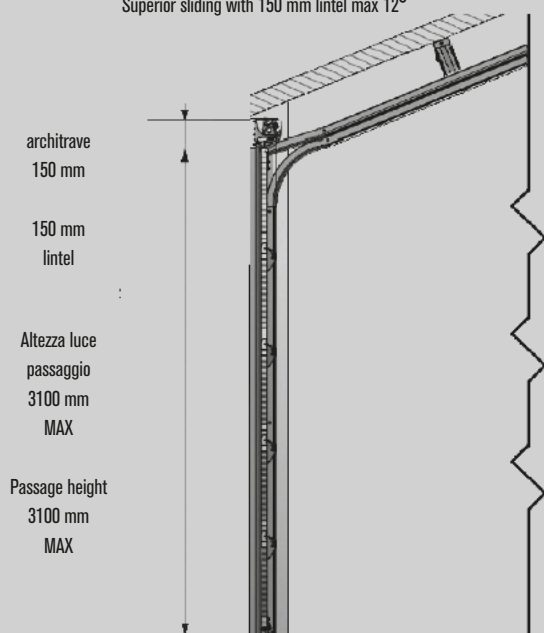

### VERSIONE | VERSION

### WD

Scorrimento superiore inclinato con architrave 250 mm MAX 22°  
Superior sliding with 250 mm lintel MAX 22°

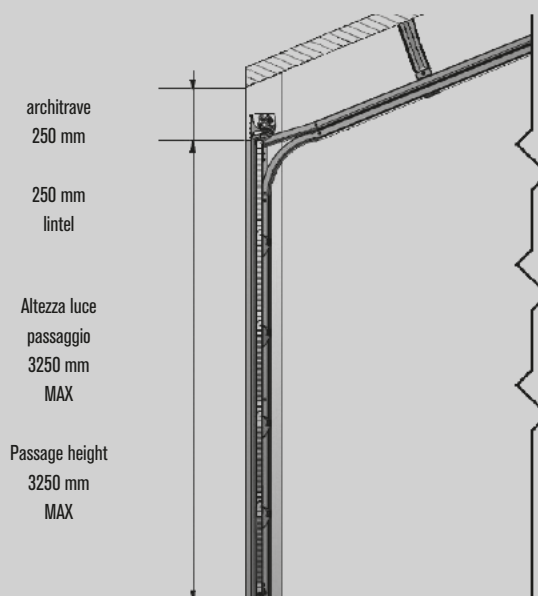

## SEZIONI ORIZZONTALI SERIE SR HORIZONTAL SECTIONS SR SERIES

### VERSIONE | VERSION ST

Portone installabile con battuta destra e sinistra già esistenti. In questo caso non sono necessarie strutture in tubolare extra per il fissaggio.

It can be installed on a structure with already existing left/right jambs. In this case, extra tubular structures to fix are not necessary.

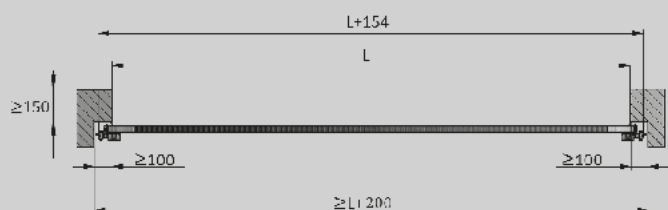

### VERSIONE | VERSION TD

Portone installabile con battuta destra esistente e sinistra mancante. In questo caso è necessaria una struttura in tubolare per il fissaggio.

It can be installed on a structure with only the right jamb. One tubular structure to fix is necessary.

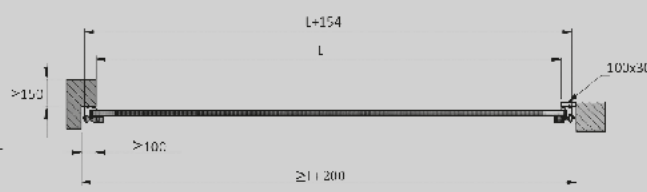

### VERSIONE | VERSION TS

Portone installabile su struttura con battuta destra mancante e sinistra esistente. In questo caso è necessaria una struttura in tubolare per il fissaggio.

It can be installed on a structure with only the left jamb. One tubular structure to fix is necessary.

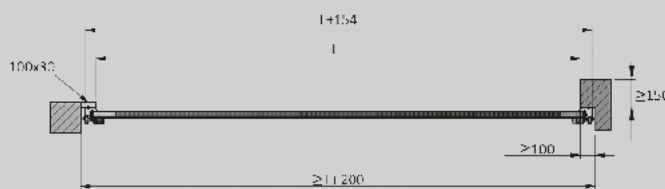

### VERSIONE | VERSION DS

Portone installabile su struttura con battuta destra e sinistra mancante. In questo caso è necessaria una struttura in tubolare per il fissaggio.

It can be installed on a structure without left and right jambs. One tubular structure to fix is necessary.



Sono disponibili tubolari in alluminio in tinte RAL oppure effetto legno da 150x30x2.5 mm e da 100x30x2 mm per realizzare le battute mancanti. Aluminum tubulars to create the missing jambs are available in RAL colours or wood-effect 150x30x2.5 mm or 100x30x2 mm.

# SEZIONI VERTICALI E ORIZZONTALI SERIE SRV HORIZONTAL VIEWS SRV SERIES

## VERSIONE | VERSION WO (SRV)

Scorrimento superiore architrave 150 mm

Superior sliding with 150 mm lintel

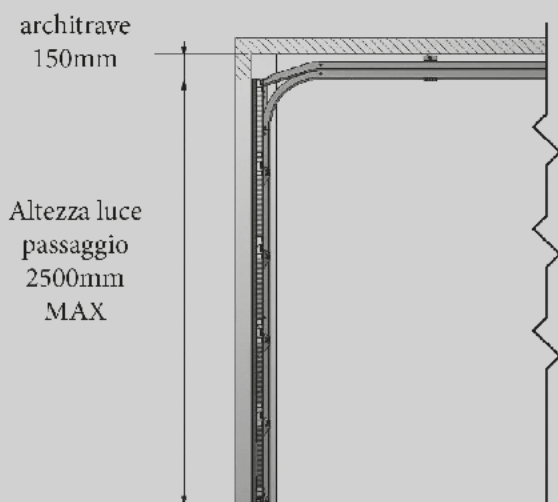

**VERSIONE ST:** Portone installabile su struttura con battuta destra e sinistra già esistenti. In questo caso non sono necessarie strutture in tubolare extra per il fissaggio.

**VERSIONE TD:** Portone installabile su struttura con battuta destra esistente e sinistra mancante. In questo caso è necessaria una struttura in tubolare per il fissaggio.

**VERSIONE TS:** Portone installabile su struttura con battuta destra mancante e sinistra esistente. In questo caso è necessaria una struttura in tubolare per il fissaggio.

**VERSIONE DS:** Portone installabile su struttura con battuta destra e sinistra mancante. In questo caso sono previsti due afferraggi.

**ST version:** it can be installed on a structure with already existing left/right jambs. In this case, extra tubular structures to fix are not necessary.

**TD version:** it can be installed on a structure with only the right jamb. One tubular structure to fix is necessary.

**TS version:** It can be installed on a structure with only the left jamb. One tubular structure to fix is necessary.

**DS Version:** it can be installed on a structure without left and right jambs. One tubular structure to fix is necessary.

### VERSIONE ST ST VERSION

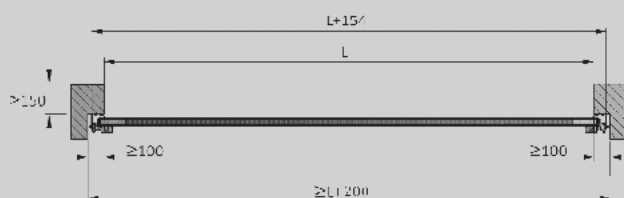

### VERSIONE TD TD VERSION

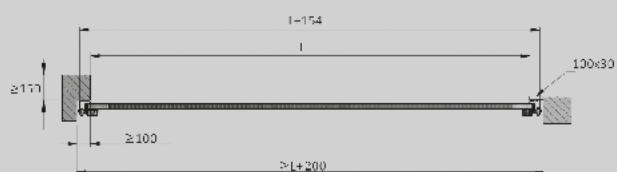

### VERSIONE TS TS VERSION

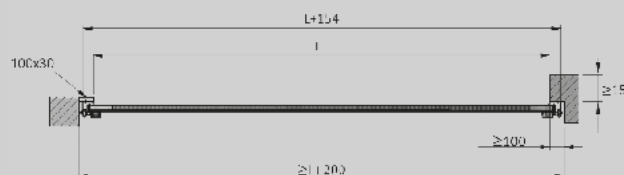

### VERSIONE DS DS VERSION



Sono disponibili tubolari in alluminio in tinte RAL oppure effetto legno da 150x30x2.5 mm e da 100x30x2 mm per realizzare le battute mancanti. Aluminum tubulars to create the missing jambs are available in RAL colours or wood-effect 150x30x2.5 mm or 100x30x2 mm.

## SEZIONI VERTICALI SERIE SLD-SLS SLD-SLS SERIES VERTICAL VIEWS

### VERSIONE A VERSION A

Non necessita di tubolare per architrave.

No tubular needed for lintel.

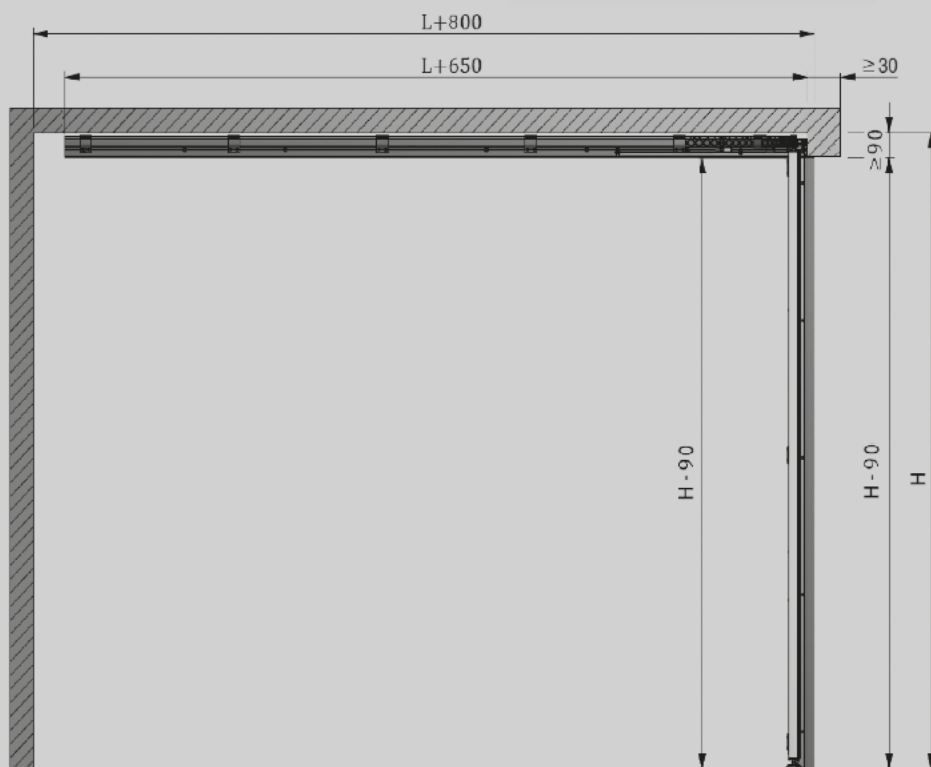

### VERSIONE B VERSION B

Prevede tubolare per architrave  $100 \times 30 \times 2$  mm.

Lintel tubular  $100 \times 30 \times 2$  mm is required.

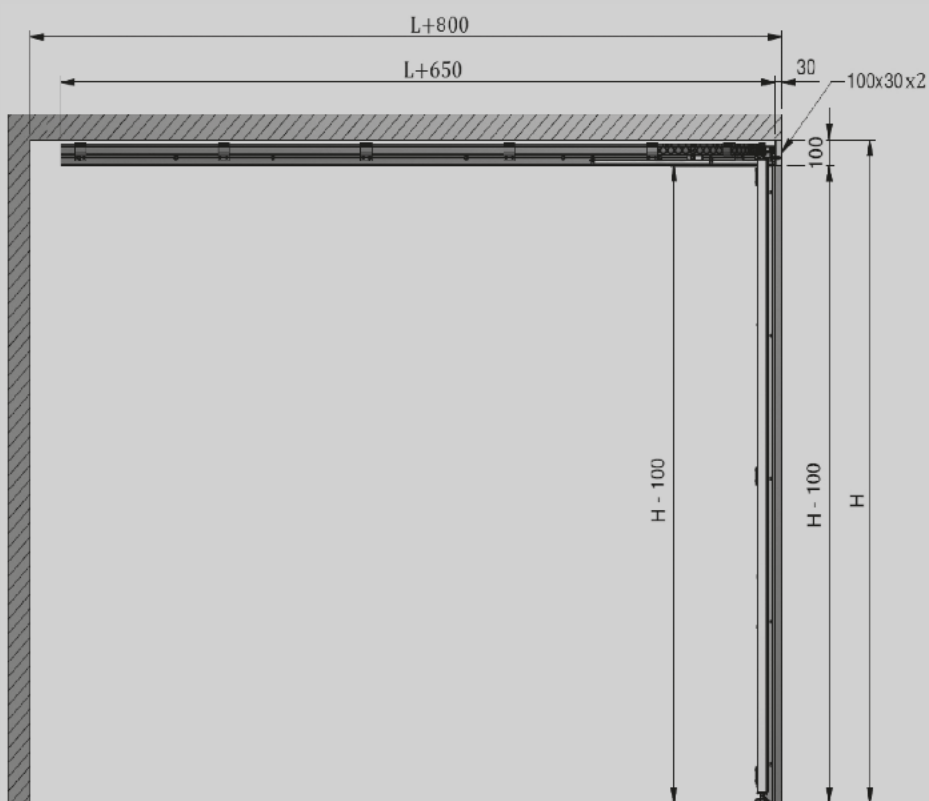

# SEZIONI ORIZZONTALI SERIE SLD-SLS SLS-SLD SERIES HORIZONTAL VIEWS

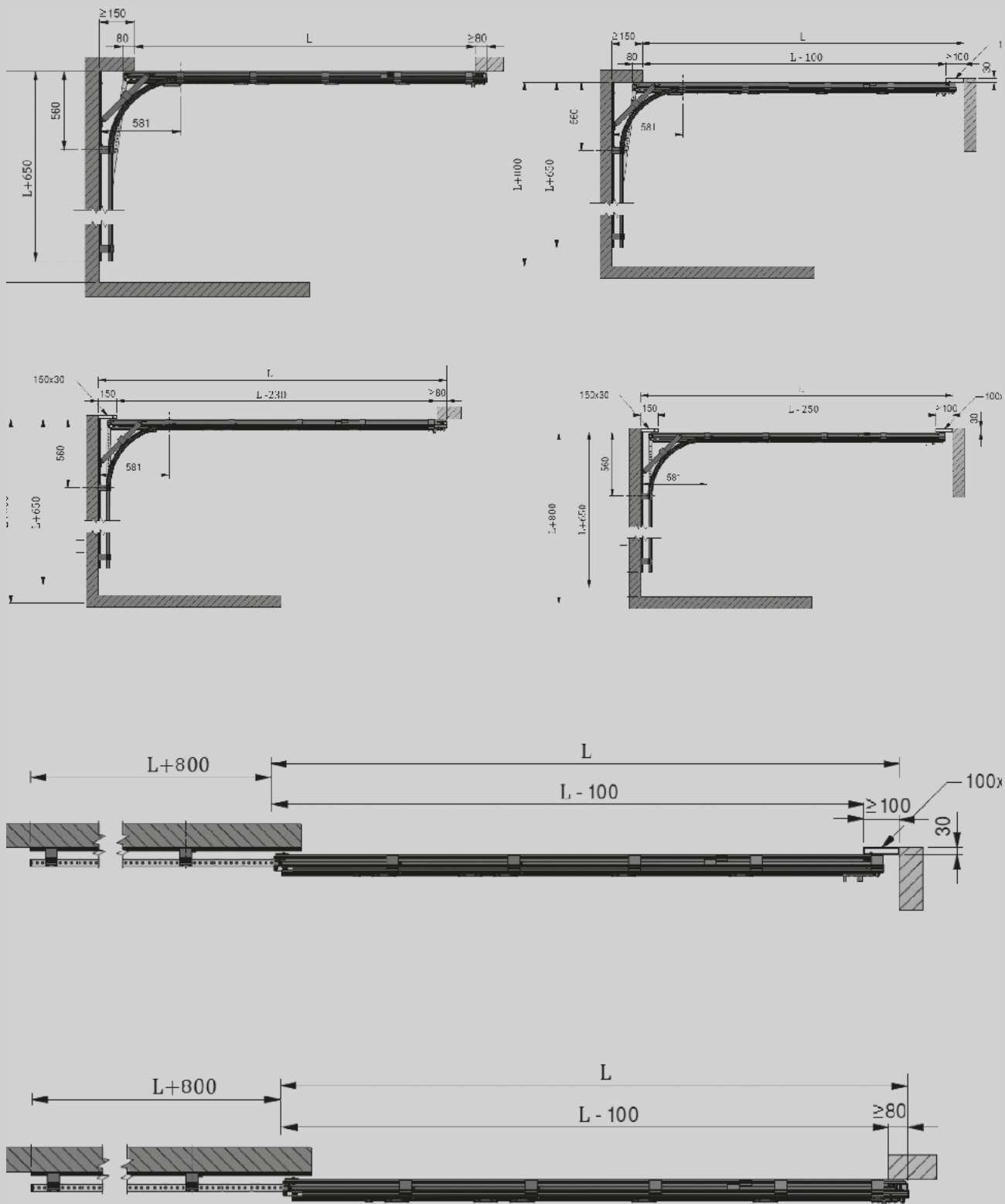

# CAPITOLATO PORTE SEZIONALI RESIDENZIALI LATERALI

## Pannello coibentato in doppia lamiera

Le porte sezionali residenziali laterali, sono costruite nelle seguenti configurazioni d'apertura:

- SLS\_dx\_90°
- SLS\_sx\_90°
- SLS\_dx\_0°
- SLS\_sx\_0°
- SLD\_dx\_90°\_sx\_90°
- SLD\_dx\_90°\_sx\_0°
- SLD\_dx\_0°\_sx\_90°
- SLD\_dx\_0°\_sx\_0°

### ANTA MOBILE COMPOSTA DA PANNELLI COIBENTATI NELLA TIPOLOGIA:

- SAO PAOLO = bidoga - finitura liscia;
- TOCANTINS = bidoga - finitura preverniciato/plasticato finto legno;
- GOIAS = bidoga - finitura goffrato legno;
- AMAPÀ = multidoga - finitura liscia;
- SERGIPE = multidoga - finitura preverniciato/plasticato finto legno;
- PARANÀ = multidoga - finitura goffrato legno
- RONDONIA = piana - finitura liscia;
- AMAZONAS = piana - finitura preverniciato/plasticato finto legno;
- BAHIA = piana - goffrato legno
- PARÀ = veneziana - finitura liscia

di spessore 40 mm, h=500 o 610mm, tipologia antipizzico, realizzati con lamiera in acciaio preverniciato o plasticato, di spessore 0,5 mm e coibentati con poliuretano espanso di densità 35/40 kg/mc, esente da CFC (trasmissione termica dichiarata nella tabella DATI TECNICI);

Profilo cornice pannelli in alluminio verniciato nero opaco ral 9004;  
profilo telaio perimetrale in alluminio verniciato ral 9004;  
profilo di battuta in alluminio anodizzato nero;  
profilo guida inferiore alluminio anodizzato nero;  
profilo guida superiore in alluminio grezzo;  
profilo soglia in alluminio nero anodizzato;  
cerniere intermedie in acciaio di colore bianco;  
carrelli di scorrimento superiori con vite per regolazione in altezza ;  
curva iniettata grigio ral 7038 in plastica formata da n°2 curve uguali a 45°;  
braccio multiposizione grezzo sp.6 mm per chiusura ultimo pannello;  
maniglia in nylon o zama, installati sul pannello in chiusura.

Su richiesta: oblò ovali, rettangolari, quadrati, tondi o griglie di areazione;  
pannelli in alluminio PANORAMA tamponati con metacrilato singolo o doppio,  
rete stirata romboidale o quadrata da 2 o 3 mm con areazione 50/81%

**Conforme ai requisiti di sicurezza del CPR 305-2011, UNI EN 13241-1 e direttiva macchine 2006/42/CE.**

**Prestazioni come da tabella DATI TECNICI**

## Pannello coibentato in legno

Le porte sezionali residenziali laterali, sono costruite nelle seguenti configurazioni d'apertura:

- SLS\_dx\_90°
- SLS\_sx\_90°
- SLS\_dx\_0°
- SLS\_sx\_0°
- SLD\_dx\_90°\_sx\_90°
- SLD\_dx\_90°\_sx\_0°
- SLD\_dx\_0°\_sx\_90°
- SLD\_dx\_0°\_sx\_0°

### ANTA MOBILE COMPOSTA DA PANNELLI COIBENTATI NELLA TIPOLOGIA:

- MADEIRA = estetica 1 - piana;
- MADEIRA = estetica 2 - quadra;
- MADEIRA = estetica 3 - multidoga verticale passo 100;

di spessore 40 mm, h=variabile da 400mm a 550mm, in base all'altezza del Manto, tipologia antipizzico, realizzati con legno di Okumè, multistrato di 5 mm e coibentati con nido d'ape continuo tipo KH 30, esente da CFC (trasmissione termica dichiarata nella tabella DATI TECNICI);

Profilo cornice pannelli in alluminio verniciato nero opaco ral 9004;  
profilo telaio perimetrale in alluminio verniciato ral 9004;  
profilo di battuta in alluminio anodizzato nero;  
profilo guida inferiore alluminio anodizzato nero;  
profilo guida superiore in alluminio grezzo;  
profilo soglia in alluminio nero anodizzato;  
cerniere intermedie a scomparsa in PA6 di colore nero;  
carrelli di scorrimento superiori con vite per regolazione in altezza;  
curva iniettata grigio ral 7038 in plastica formata da n°2 curve uguali a 45°;  
braccio multiposizione grezzo sp.6 mm per chiusura ultimo pannello;  
maniglia in nylon o zama installati sul pannello in chiusura.

Su richiesta: oblò quadrati o griglie di areazione.

**Conforme ai requisiti di sicurezza del CPR 305-2011, UNI EN 13241-1 e direttiva macchine 2006/42/CE.**

**Prestazioni come da tabella DATI TECNICI**



# RESIDENTIAL SECTIONAL LATERAL DOORS SPECIFICATIONS

## Insulated panel with double metal sheet

Residential sectional lateral doors are manufactured in the following opening configurations:

- SLS\_dx\_90°
- SLS\_sx\_90°
- SLS\_dx\_0°
- SLS\_sx\_0°
- SLD\_dx\_90°\_sx\_90°
- SLD\_dx\_90°\_sx\_0°
- SLD\_dx\_0°\_sx\_90°
- SLD\_dx\_0°\_sx\_0°

### MOVABLE DOOR LEAF CONSISTING OF INSULATED PANELS AS FOLLOWS:

- SAO PAOLO = double-slat - smooth finish;
- TOCANTINS = double-slat - faux wood pre-painted/laminated finish;
- GOIAS = double-slat - embossed wood finish;
- AMAPÁ = multi-slat - smooth finish;
- SERGIPE = multi-slat - faux wood pre-painted/laminated finish;
- PARANÁ = multi-slat - embossed wood finish
- RONDONIA = planar - smooth finish;
- AMAZONAS = planar - faux wood pre-painted/laminated finish;
- BAHIA = flat - embossed wood;
- PARÁ = Venetian - smooth finish;

with thickness of 40 mm, h=500 or 610 mm, anti-pinch type, made of pre-painted or laminated steel sheet, thickness 0.5 mm and insulated with expanded polyurethane with a density of 35/40 kg/m<sup>3</sup>, free from CFC (thermal conductivity declared in the TECHNICAL DATA);

Aluminum panel frame profile in ral 9004 painted;  
Aluminum perimetral frame profile in ral 9004 painted;  
black anodized aluminum jamb profile;  
black anodized aluminum lower guide profile;  
upper guide profile in raw aluminum;  
black painted profile for lowered threshold;  
concealed intermediate hinges in black PA6;  
upper sliding trolleys with screw for height adjustment;  
injected curve ral 7038 grey plastic formed by n°2 curves equal to 45°;  
multi-position raw arm thick 6 mm for last panel closing;  
nylon or zama handle, installed on base panel.

On request, oval, rectangular, square and round windows or ventilation grille;  
aluminum PANORAMA panels partitioned with single or double methacrylate glazing, diamond-shaped or square stretched mesh 2 or 3 mm with 50/81 % ventilation.

**Complaint with safety requirements of CPR 305-2011, UNI EN 13241-1 and Machine Directive 2006/42/EC.**

**Performance as indicated in the TECHNICAL DATA table**

## Wood insulated panel

Residential sectional lateral doors are manufactured in the following opening configurations:

- SLS\_dx\_90°
- SLS\_sx\_90°
- SLS\_dx\_0°
- SLS\_sx\_0°
- SLD\_dx\_90°\_sx\_90°
- SLD\_dx\_90°\_sx\_0°
- SLD\_dx\_0°\_sx\_90°
- SLD\_dx\_0°\_sx\_0°

### MOVABLE DOOR LEAF CONSISTING OF INSULATED PANELS AS FOLLOWS:

- MADEIRA = pattern 1 - planar;
- MADEIRA = pattern 2 - square;
- MADEIRA = pattern 3 - vertical multi-slat pitch 100;

with thickness of 40 mm, h=400 or 550 mm, based on the height of the door leaf, anti-pinch type, made of multi-layered 5 mm Okumè wood, insulated with KH 30-type honeycomb material, free from CFC (thermal transfer declared in the TECHNICAL DATA);

Aluminum panel frame profile in ral 9004 painted;  
Aluminum perimetral frame profile in ral 9004 painted;  
black anodized aluminum jamb profile;  
black anodized aluminum lower guide profile;  
upper guide profile in raw aluminum;  
black painted profile for lowered threshold;  
concealed intermediate hinges in black PA6;  
upper sliding trolleys with screw for height adjustment;  
injected curve ral 7038 grey plastic formed by n°2 curves equal to 45°;  
multi-position raw arm thick 6 mm for last panel closing;  
nylon or zama handle, installed on base panel.

On request, square windows or ventilation grille.

**Complaint with safety requirements of CPR 305-2011, UNI EN 13241-1 and Machine Directive 2006/42/EC.**

**Performance as indicated in the TECHNICAL DATA table**

# TABELLA DATI TECNICI

	WA	WB	WC	WD	WM	WN	WO
<b>Resistenza al carico del vento EN 12424</b>							
▪ Manto senza porta pedonale inserita, classe (a)	2	2	2	2	2	2	2
▪ Manto con porta pedonale Standard 800x1867, LP ≤ 4000, classe (b)	3	3	3	3	3	3	3
▪ Manto con porta pedonale Standard 800x1867, LP > 4000 e ≤ 5000, classe	2	2	2	2	2	2	2
<b>Tenuta all'acqua EN 12425</b>							
▪ Manto senza porta pedonale inserita, classe	30 (70 Pa)	30 (70 Pa)	30 (70 Pa)	30 (70 Pa)	30 (70 Pa)	30 (70 Pa)	30 (70 Pa)
<b>Permeabilità all'aria EN 12426</b>							
▪ Manto senza porta pedonale inserita, classe	2	2	2	2	2	2	2
▪ Manto con porta pedonale inserita, classe (c)	1	1	1	1	1	1	1
<b>Insonorizzazione EN 717-1</b>							
▪ Manto senza porta pedonale inserita R = ... dB (d)	22	22	22	22	22	22	22
▪ Manto con porta pedonale inserita R = ... dB (d)	20	20	20	20	20	20	20
<b>Isolamento Termico EN 13241:2016</b>							
<b>Manto coibentato, senza porta pedonale, U = W/ (m<sup>2</sup>·K)</b>							
▪ Manto coibentato con pannello da 40 senza porta (e) Dimensioni LxH 5500x5500	1.1	1.1	1.1	1.1	1.1	1.1	1.1
Dimensioni LxH 3500x3500	1.3	1.3	1.3	1.3	1.3	1.3	1.3
Dimensioni LxH 3500x2500	1.5	1.5	1.5	1.5	1.5	1.5	1.5
▪ Differenza con Oblò U = W/ (m <sup>2</sup> ·K) (incrementare)	+0.1	+0.1	+0.1	+0.1	+0.1	+0.1	+0.1
▪ Pannello da 40, U = W/ (m <sup>2</sup> ·K) (f)	0.48	0.48	0.48	0.48	0.48	0.48	0.48
▪ Pannello da 50 = W/ (m <sup>2</sup> ·K) (f)	0.39	0.39	0.39	0.39	0.39	0.39	0.39
▪ Pannello da 60 = W/ (m <sup>2</sup> ·K) (f)	0.33	0.33	0.33	0.33	0.33	0.33	0.33
▪ Pannello da 80 = W/ (m <sup>2</sup> ·K) (f)	0.25	0.25	0.25	0.25	0.25	0.25	0.25
<b>Manto senza porta pedonale inserita, U = W/ (m<sup>2</sup>·K)</b>							
▪ Vetro metacrilato singolo, U = W/ (m <sup>2</sup> ·K) (g)	5,6	5,6	5,6	5,6	5,6	5,6	5,6
▪ Vetro metacrilato doppio U = W/ (m <sup>2</sup> ·K) (h)	3,4	3,4	3,4	3,4	3,4	3,4	3,4
<b>Struttura Tubolare</b>							
▪ Tubolare in alluminio per architrave (mm)	150x30	150x30	150x30	150x30	150x30	150x30	150x30
▪ Tubolare in alluminio per spalle (mm)	100x30	100x30	100x30	100x30	100x30	100x30	100x30
<b>Dimensioni Manto</b>							
▪ Larghezza max. mm, L	6500	6500	6500	6500	6500	6500	3500
▪ Altezza max. mm, H	3100	3250	3100	3250	3100	3100	2500
<b>Composizione del manto</b>							
▪ Acciaio a doppia parete 40 mm	▲	▲	▲	▲	▲	▲	▲
▪ Acciaio a doppia parete 50 mm	★	★	★	★	★	★	★
▪ Acciaio a doppia parete 60 mm	★	★	★	★	★	★	★
▪ Acciaio a doppia parete 80 mm	∥	∥	∥	∥	∥	∥	∥
▪ Alluminio, profilo da 40 mm	▲	▲	▲	▲	▲	▲	▲
<b>Superficie del manto</b>							
▪ Acciaio zincato, pre-verniciato RAL 9010	▲	▲	▲	▲	▲	▲	▲
▪ Acciaio zincato, pre-verniciato RAL a scelta	★	★	★	★	★	★	★
<b>Rinforzo manto per resistenza al vento (cl.2)</b>							
▪ Pannello da 500/610x40 - Senza omega	<=5000	<=5000	<=5000	<=5000	<=5000	<=5000	<=5000
▪ Pannello da 500/610x40 - Con 1 omega	<=7500	<=7500	<=7500	<=7500	<=7500	<=7500	<=7500
<b>Rinforzo manto per colori scuri (irraggiamento)</b>							
▪ Pannello da 500/610x40 - Senza omega	<=5000	<=5000	<=5000	<=5000	<=5000	<=5000	<=5000
▪ Pannello da 500/610x40 - Con 1 omega	<=7500	<=7500	<=7500	<=7500	<=7500	<=7500	<=7500
Sono da evitare i colori scuri nei portoni in acciaio a doppia parete esposti al sole, perché la flessione dei pannelli può compromettere la funzionalità del manto. Silvelox consiglia per questo tipo di porte l'inserimento di un omega aggiuntivo per pannello da 4000 mm (opzionale su richiesta del cliente).							
<b>Porta pedonale inserita</b>							
▪ Con soglia ribassata	▲	▲	▲	▲	▲	▲	∥
▪ Con zoccolo standard 130 mm	▲	▲	▲	▲	▲	▲	∥
<b>Porta pedonale laterale</b>	▲	▲	▲	▲	▲	▲	▲

<b>Finestrature</b> <ul style="list-style-type: none"> <li>▪ Rettangolare 324x490</li> <li>▪ Rettangolare 322x488 con inglesina</li> <li>▪ Rettangolare 364x530</li> <li>▪ Rettangolare antieffrazione 146x609</li> <li>▪ Quadrato 290x290</li> <li>▪ Ovale 340x660</li> <li>▪ Tondo Ø330</li> <li>▪ Tondo Ø330 in alluminio spazzolato</li> <li>▪ Griglia di areazione 132x338</li> <li>▪ Una o più sezioni panorama con vetro singolo o doppio</li> <li>▪ Una o più sezioni panorama con rete metallica</li> </ul>	▲	▲	▲	▲	▲	▲	▲
	▲	▲	▲	▲	▲	▲	▲
	▲	▲	▲	▲	▲	▲	▲
	▲	▲	▲	▲	▲	▲	▲
	▲	▲	▲	▲	▲	▲	▲
	▲	▲	▲	▲	▲	▲	▲
	▲	▲	▲	▲	▲	▲	▲
	★	★	★	★	★	★	★
	▲	▲	▲	▲	▲	▲	▲
	▲	▲	▲	▲	▲	▲	▲
	▲	▲	▲	▲	▲	▲	▲
	▲	▲	▲	▲	▲	▲	▲
	▲	▲	▲	▲	▲	▲	▲
<b>Guarnizioni</b> <ul style="list-style-type: none"> <li>▪ Perimetrale su 4 lati</li> <li>▪ Guarnizione intermedia tra gli elementi del Manto</li> </ul>	▲	▲	▲	▲	▲	▲	▲
	▲	▲	▲	▲	▲	▲	▲
<b>Sistemi di chiusura</b> <ul style="list-style-type: none"> <li>▪ Catenaccio con pomello</li> <li>▪ Maniglia serratura con pomolo con chiusura laterale</li> </ul>	★	★	★	★	★	★	★
	★	★	★	★	★	★	★
<b>Sicurezze</b> <ul style="list-style-type: none"> <li>▪ Protezione salva dita su pannello</li> <li>▪ Protezione anti-convogliamento laterale - su ruote</li> <li>▪ Sicurezza contro rottura sistema di sospensione</li> <li>▪ Sicurezza contro rottura molle</li> </ul>	▲	▲	▲	▲	▲	▲	▲
	▲	▲	▲	▲	▲	▲	▲
	▲	▲	▲	▲	▲	▲	▲
	▲	▲	▲	▲	▲	▲	▲
<b>Possibilità di fissaggio</b> <ul style="list-style-type: none"> <li>▪ Calcestruzzo</li> <li>▪ Acciaio</li> <li>▪ Muratura</li> <li>▪ Altre possibilità su richiesta</li> </ul>	▲	▲	▲	▲	▲	▲	▲
	▲	▲	▲	▲	▲	▲	▲
	▲	▲	▲	▲	▲	▲	▲
	▲	▲	▲	▲	▲	▲	▲

**NOTE:**

▲ = Standard

★ = Su richiesta

(a) Misurata su una porta 6500x3500

(b) Testata anta 3280x2550 (con porta pedonale 800x1800 su 4 pannelli con zoccolo ribassato)

(c) Misurata su una porta 6500x3500

(d) Misurata su una porta 3760x3000

(e) Valore calcolato su una porta coibentata 6500x3500, con pannello da 40, senza porta pedonale

(f) Valore dichiarato dal produttore dei pannelli

(g) Valore calcolato su un Manto completo 6000x5500

(h) Valore calcolato su un Manto completo 4000x3400

# TECHNICAL DATA TABLE

	WA	WB	WC	WD	WM	WN	WO
<b>Wind resistance EN 12424</b>							
▪ Door without pedestrian door, class (a)	2	2	2	2	2	2	2
▪ Door with Standard pedestrian door 800x1867, LP ≤ 4000, class (b)	3	3	3	3	3	3	3
▪ Door with Standard pedestrian door 800x1867, LP > 4000 e <= 5000, classe	2	2	2	2	2	2	2
<b>Water resistance EN 12425</b>							
▪ Door without pedestrian door, class	30 (70 Pa)	30 (70 Pa)	30 (70 Pa)	30 (70 Pa)	30 (70 Pa)	30 (70 Pa)	30 (70 Pa)
<b>Air permeability EN 12426</b>							
▪ Door without pedestrian door, class	2	2	2	2	2	2	2
▪ Door with pedestrian door, class (c)	1	1	1	1	1	1	1
<b>Insonorization EN 717-1</b>							
▪ Door without pedestrian door R = ... dB (d)	22	22	22	22	22	22	22
▪ Door with pedestrian door R = ... dB (d)	20	20	20	20	20	20	20
<b>Thermal insulation EN 13241:2016</b>							
<b>Insulated panel, without pedestrian door, U = W/ (m<sup>2</sup>·K)</b>							
▪ Insulated panel 40 mm thick without pedestrian door (e) Dimensions WxH 5500x5500	1.1	1.1	1.1	1.1	1.1	1.1	1.1
Dimensions WxH 3500x3500	1.3	1.3	1.3	1.3	1.3	1.3	1.3
Dimensions WxH 3500x2500	1.5	1.5	1.5	1.5	1.5	1.5	1.5
▪ Difference with a porthole U = W/ (m <sup>2</sup> ·K) (increasing)	+0.1	+0.1	+0.1	+0.1	+0.1	+0.1	+0.1
▪ Panel 40, U = W/ (m <sup>2</sup> ·K) (f)	0.48	0.48	0.48	0.48	0.48	0.48	0.48
▪ Panel 50 = W/ (m <sup>2</sup> ·K) (f)	0.39	0.39	0.39	0.39	0.39	0.39	0.39
▪ Panel 60 = W/ (m <sup>2</sup> ·K) (f)	0.33	0.33	0.33	0.33	0.33	0.33	0.33
▪ Panel 80 = W/ (m <sup>2</sup> ·K) (f)	0.25	0.25	0.25	0.25	0.25	0.25	0.25
<b>Panel without pedestrian door, U = W/ (m<sup>2</sup>·K)</b>							
▪ Single methacrylate panel, U = W/ (m <sup>2</sup> ·K) (g)	5,6	5,6	5,6	5,6	5,6	5,6	5,6
▪ Double methacrylate panel U = W/ (m <sup>2</sup> ·K) (h)	3,4	3,4	3,4	3,4	3,4	3,4	3,4
<b>Tubular structure</b>							
▪ Tubolare in alluminio per architrave (mm)	150x30	150x30	150x30	150x30	150x30	150x30	150x30
▪ Tubolare in alluminio per spalle (mm)	100x30	100x30	100x30	100x30	100x30	100x30	100x30
<b>Panel dimensions</b>							
▪ Width max. mm, W	6500	6500	6500	6500	6500	6500	3500
▪ Height max. mm, H	3100	3250	3100	3250	3100	3100	2500
<b>Panel composition</b>							
▪ Double-walled steel 40 mm	▲	▲	▲	▲	▲	▲	▲
▪ Double-walled steel 50 mm	★	★	★	★	★	★	★
▪ Double-walled steel 60 mm	★	★	★	★	★	★	★
▪ Double-walled steel 80 mm	∥	∥	∥	∥	∥	∥	∥
▪ Aluminum, profile 40 mm	▲	▲	▲	▲	▲	▲	▲
<b>Panel surface</b>							
▪ Galvanized steel, pre-painted RAL 9010	▲	▲	▲	▲	▲	▲	▲
▪ Galvanized steel, pre-painted RAL at choice	★	★	★	★	★	★	★
<b>Panel reinforcing for wind resistance (cl.2)</b>							
▪ Panel 500/610x40 - Without omega	<=5000	<=5000	<=5000	<=5000	<=5000	<=5000	<=5000
▪ Panel 500/610x40 - With 1 omega	<=7500	<=7500	<=7500	<=7500	<=7500	<=7500	<=7500
<b>Panel reinforcing for dark colors (irradiation)</b>							
▪ Panel 500/610x40 - Without omega	<=5000	<=5000	<=5000	<=5000	<=5000	<=5000	<=5000
▪ Panel 500/610x40 - With 1 omega	<=7500	<=7500	<=7500	<=7500	<=7500	<=7500	<=7500
It is suggested to avoid dark colors when ordering steel panels which will be directly exposed to the sun, as the bending of the panels would compromise the operation of the door. Silvelox suggests in case of order to add 1 omega each panel (optional, on customer request).							
<b>Pedestrian door</b>							
▪ With lowered threshold	▲	▲	▲	▲	▲	▲	∥
▪ With standard threshold 130 mm	▲	▲	▲	▲	▲	▲	∥
<b>Lateral pedestrian door</b>	▲	▲	▲	▲	▲	▲	▲

<b>Windows</b> <ul style="list-style-type: none"> <li>▪ Rectangular 324x490</li> <li>▪ Rectangular 322x488 with Georgian bar</li> <li>▪ Rectangular 364x530</li> <li>▪ Rectangular anti-intrusion 146x609</li> <li>▪ Square 290x290</li> <li>▪ Oval 340x660</li> <li>▪ Round Ø330</li> <li>▪ Round Ø330 in brushed aluminium</li> <li>▪ Ventilation grille 132x338</li> <li>▪ One or more panorama sections with single or double glazing</li> <li>▪ One or more panorama sections with metal net</li> </ul>	▲	▲	▲	▲	▲	▲	▲
	▲	▲	▲	▲	▲	▲	▲
	▲	▲	▲	▲	▲	▲	▲
	▲	▲	▲	▲	▲	▲	▲
	▲	▲	▲	▲	▲	▲	▲
	▲	▲	▲	▲	▲	▲	▲
	▲	▲	▲	▲	▲	▲	▲
	★	★	★	★	★	★	★
	▲	▲	▲	▲	▲	▲	▲
	▲	▲	▲	▲	▲	▲	▲
	▲	▲	▲	▲	▲	▲	▲
	▲	▲	▲	▲	▲	▲	▲
<b>Seals</b> <ul style="list-style-type: none"> <li>▪ Perimeter seal on 4 sides</li> <li>▪ Intermediate seal between the door leaf elements</li> </ul>	▲	▲	▲	▲	▲	▲	▲
	▲	▲	▲	▲	▲	▲	▲
<b>Closure system</b> <ul style="list-style-type: none"> <li>▪ Security chain with knob</li> <li>▪ Handle lock with knob and side closure</li> </ul>	★	★	★	★	★	★	★
	★	★	★	★	★	★	★
<b>Safety devices</b> <ul style="list-style-type: none"> <li>▪ Finger guard on panel</li> <li>▪ Side movement prevention – on wheels</li> <li>▪ Suspension system safety break device</li> <li>▪ Spring break safety device</li> </ul>	▲	▲	▲	▲	▲	▲	▲
	▲	▲	▲	▲	▲	▲	▲
	▲	▲	▲	▲	▲	▲	▲
	▲	▲	▲	▲	▲	▲	▲
<b>Anchoring options</b> <ul style="list-style-type: none"> <li>▪ Concrete</li> <li>▪ Steel</li> <li>▪ Masonry</li> <li>▪ Other options on request</li> </ul>	▲	▲	▲	▲	▲	▲	▲
	▲	▲	▲	▲	▲	▲	▲
	▲	▲	▲	▲	▲	▲	▲
	▲	▲	▲	▲	▲	▲	▲

**NOTES:**

▲ = Standard

★ = On request

(a) Measured on one door 6500x3500

(b) Door head 3280x2550 (with wicket door 800x1800 on 4 panels with lowered plinth)

(c) Measured on one door 6500x3500

(d) Measured on one door 3760x3000

(e) Value calculated on one insulated door 6500x3500, with panel 40, with no wicket door

(f) Value declared by panel manufacturer

(g) Value calculated on complete door leaf 6000x5500

(h) Value calculated on complete door leaf 4000x3400

# PROCESSI INDUSTRIALI ALL'AVANGUARDIA INDUSTRIA 4.0 ADVANCED INDUSTRIAL PROCESSES



Impianto lavorazione pannelli.  
Panel processing plant.



Sistema di controllo automatizzato.  
Automated control system.



Magazzino pannelli semilavorati.  
Semi-finished panels warehouse.

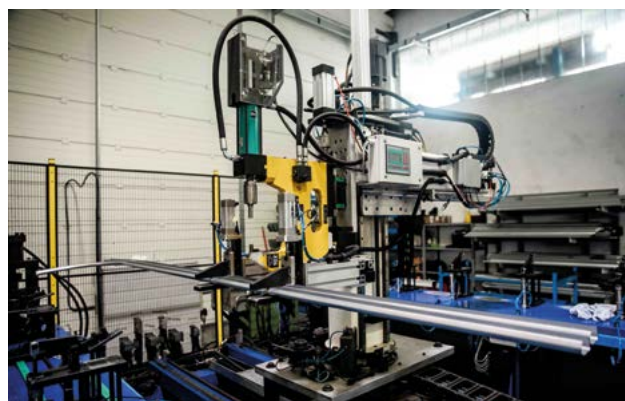

Robot di montaggio strutture metalliche porte sezionali.  
Robot for assembling metal structures for sectional doors.



Profilatura lamiera per produzione strutture metalliche per porte.  
Profiling department for door metal trackset production.

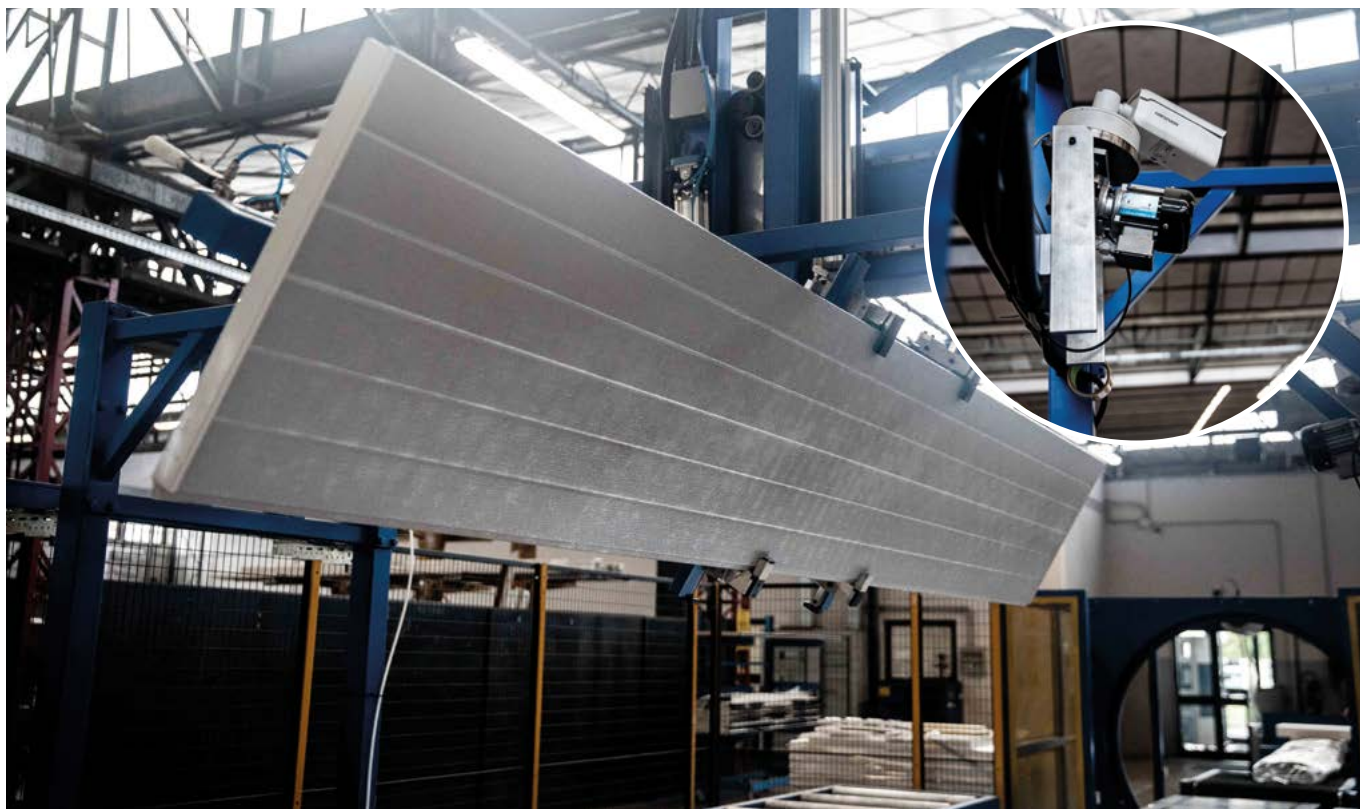

Stazione di controllo qualità estetica.  
Aesthetic quality control station.



Stazione automatica pannelli semilavorati.  
Automatic station for semi-finished panels.



Le condizioni di vendita e certificazioni sono visibili sul sito [www.silvelox.it](http://www.silvelox.it)  
General sales conditions and certifications available on our website [www.silvelox.it](http://www.silvelox.it)

**SEIP**  
RESIDENTIAL DOORS

SILVELOX GROUP SPA  
[www.silvelox.it](http://www.silvelox.it)

P.IVA 02381120225

Headquarters and Production plant:

Viale Venezia, 37 I-38050 Castelnuovo - Trento - Italy

Tel. (+39) 0461 755 755 - Fax (+39) 0461 752 466

[info@silvelox.it](mailto:info@silvelox.it) - [silvelox@cgn.legalmail.it](mailto:silvelox@cgn.legalmail.it) - [www.silvelox.it](http://www.silvelox.it)

Production plant:

Via Rossi, 14 I-25010 Remedello - Brescia - Italy

Tel. (+39) 030 258 5500 - Fax (+39) 030 258 2537

[seip@silvelox.it](mailto:seip@silvelox.it) - [www.seipdoors.it](http://www.seipdoors.it)



SILVELOX GROUP S.p.A. nell'intento di migliorare la qualità delle proprie porte, si riserva il diritto di apportare in qualsiasi momento modifiche al prodotto, a tutela della soddisfazione dei propri clienti.  
SILVELOX GROUP S.p.A. reserves the right to modify its products at any time to improve the quality of said products and better satisfy customers.